



BIORTHO
Always Innovating



CATALOG
2026-2027

Contents

Veterinary Orthopedic Instruments

Distraction And Reduction Tool Set	2
Micrometric Locking Forceps	3-4
Pointed Reduction Forceps/Bone Forceps	5-11
Implants Cutting Tools	12-18
Osteotomes and Mallets	19-22
Bone Curette	23
Periosteal Elevator	24
Hohman Retractor	25-26
Bone Rongeur/Bone Cutters	27-29
AO Quick Coupling Handle	30
Screwdriver+Sleeves	31-32
Drill Bits/Countersink/Taps/Drill Guides	33-37
Depth Gauge	38
Bone Plate Template/Bending Irons	39-43

Bone Models & Pre-Operative Planing

Bone Models & Pre Operative Planing Tools	45-51
---	-------

Veterinary Orthopaedic Screws

Cortex Screws	54-56
Cancellous Screws	57-58
AO Standard Locking Screw	59-60
Titanium Cortex Screw	61-62
FKS Titanium Locking Screw	63-64
Screw Caddy	65-72

Veterinary Bone Plates

Stainless Cuttable Plates	74
Stainless Cuttable Malleable Plates	75-76
Stainless Steel Round Hole Plates	77
Acetabular Plates	78
Supracondylar Plates	79
Compression Plates DCP	80
Limited Contact Compression Plates LC-DCP	81-82
Locking Compression Plates LCP	83-95
Titanium Mini Plates	96-97
TPLO Plate System	99-111

Joint And Sports Medicine

Universal Aim Device	113
Suture And Anchor System	114-118

Intramedullary Pin System

Small Animals Interlocking Nail+LOCK Set	120-121
AO Style Small Animal Rush Pin Instruments Set	122

Spinal Neurosurgery System

Skull Titanium Mesh System	124-126
VSS Spinal Fixation System	127-130
Spinal Neuro Surgical Instruments	131-136

Pin And Wire

Pin And Wire	138-141
--------------	---------

External Fixation System

Mini External Fixation System	143-144
ESF External Fixation System	145-151

Power Tool System

Spinal Neurosurgery High Speed Drill	153
Annulated Drill/Saw/Multi-Function Drill	154-161
TPLO SAW	162-163

Soft Tissue Instruments

Hemostatic Forceps/Tissue Forceps	165-166
Surgical Scissors	166-169
Needle Driver	169-170
Surgical Forceps	171
Towel Forceps	173-175
Mouth Gag	176
Retractor/Thoracic Retractor	177-181
Soft Tissue Surgical Instruments Kit	182-183
Sterilization Box	184-185

Dental Instruments

Dental Instruments	187-191
Rodent Dental Instruments	192-197

Ophthalmology Instruments

Ophthalmology Instruments	199-207
---------------------------	---------

Veterinary Orthopedic Instruments

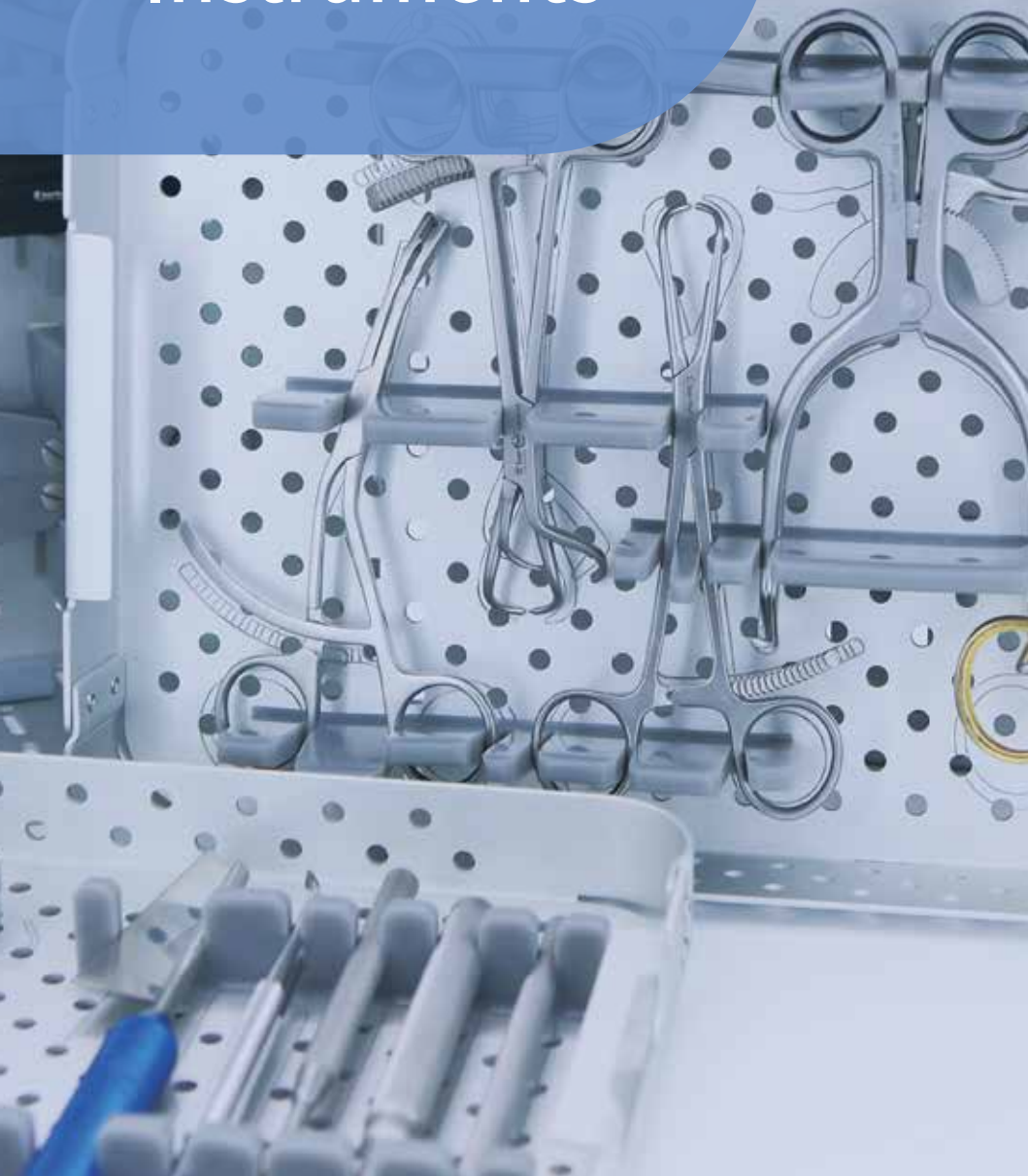

Distraction And Reduction Tool For Fractures And Osteotomy

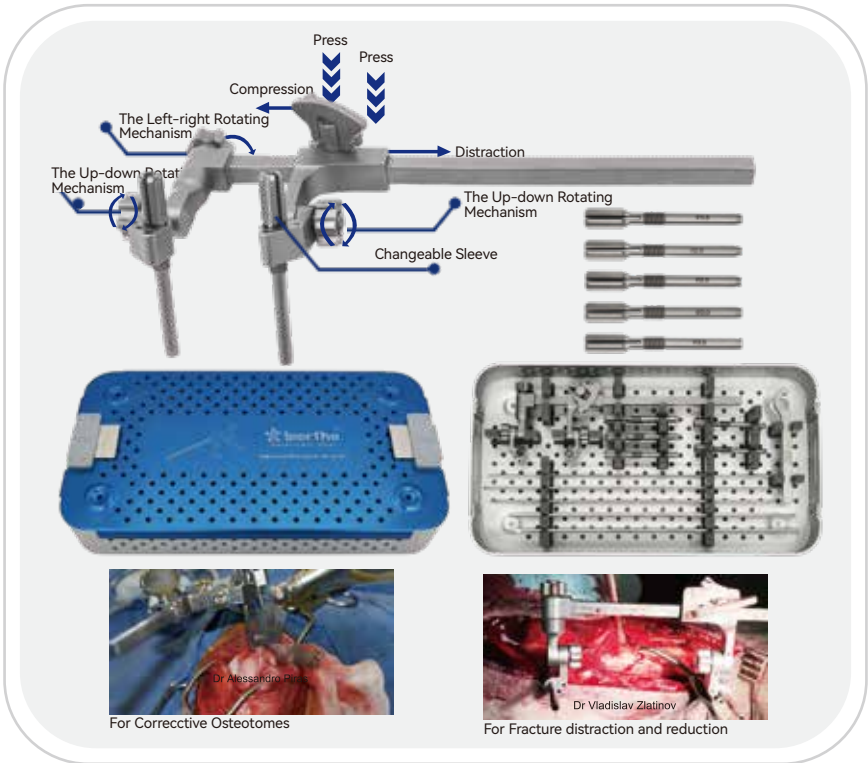

Distraction And Reduction Tool Set

Code	Products Name/Specification	Quantity
PS1525	Kirschner Wire Single Head Sharp Φ 1.5X250mm	2
PS2025	Kirschner Wire Single Head Sharp Φ 2.0X250mm	2
PS2525	Kirschner Wire Single Head Sharp Φ 2.5X250mm	2
PS3025	Kirschner Wire Single Head Sharp Φ 3.0X250mm	2
PS3525	Kirschner Wire Single Head Sharp Φ 3.5X250mm	2
DR0015	Pin Sleeve Φ 1.5	2
DR0020	Pin Sleeve Φ 2.0	2
DR0025	Pin Sleeve Φ 2.5	2
DR0030	Pin Sleeve Φ 3.0	2
DR0035	Pin Sleeve Φ 3.5	2
DR0002	Wrench	1
DR0001	Distraction And Reduction Main Body	1
DR0000	Sterilization Box For Distraction And Reduction Tool	1

Micrometric Locking Forceps

Pointed Reduction Forceps

Veterinary Use Only

Code	Specification	L
301001	Small 30mm	140mm
301002	Large 62mm	176mm



Plate Holding Forceps

Veterinary Use Only

Code	Specification	L
301003	34mm	162mm



Condyle Reduction Forceps

Veterinary Use Only

Code	Specification	L
301004	64mm	175mm



Mini Holding Forceps

Veterinary Use Only

Code	Specification	L
301005	20mm	139mm

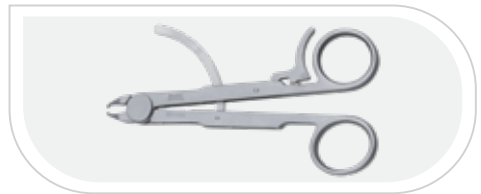

Micrometric Locking Forceps

Pointed Reduction Forceps With Aiming Device

Veterinary Use Only

Code	Products Name	Specification	L
301006	Aiming Forceps Open Range 30mm	144mm	
301106	Aiming Device	Small	
301101	Drill Sleeve	1.1mm	
301102	Drill Sleeve	1.5mm	
301103	Drill Sleeve	1.8mm	
301007	Aiming Forceps Open Range 60mm	178mm	
301107	Aiming Device	Large	
301104	Drill Sleeve	1.8mm	
301105	Drill Sleeve	2.0mm	
301108	Drill Sleeve	2.5mm	

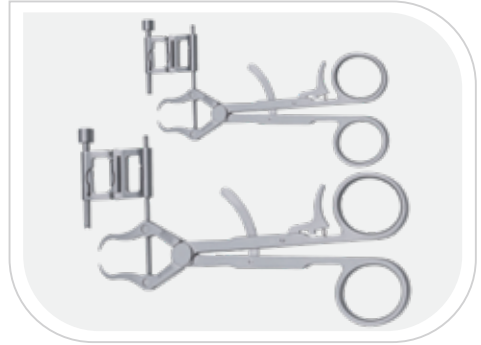

Dr Vladislav Zlatinov

Micro Bone Holding Forceps, Titanium, Super Light

Veterinary Use Only

Code	Specification	L
301008	18mm	120mm



AO Style Reduction Forceps

Pointed Reduction Forceps

Veterinary Use Only

Code	Specification	L
100000	Medium	160mm
100001	Small	135mm
100002	Very Small	100mm
100003	Large	180mm

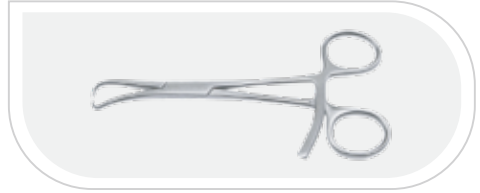

Pointed Reduction Forceps with Spinlock

Veterinary Use Only

Code	Specification	L
100004S	Small	135mm
100004	Large	180mm



Pointed Reduction Forceps With Double Racthes

Veterinary Use Only

Code	Specification	L
100005	Very Large	205mm

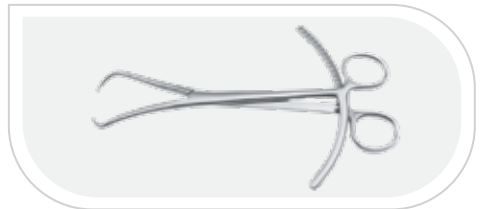

Mini Bone Forceps

Bone Holding Forceps with Jaws

Veterinary
Use Only

Code	L
100006	150mm

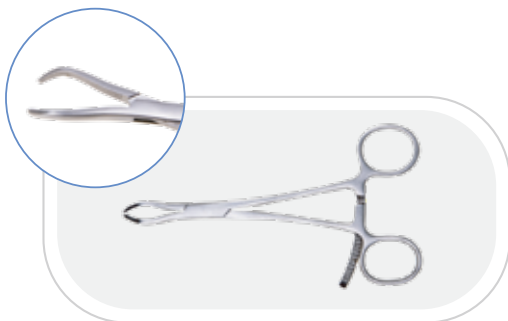

Bone Holding Forceps-Pointed With Jaws

Veterinary
Use Only

Code	L
100301	140mm



Reduction Forceps With Small Point

Veterinary
Use Only

Code	L
100302	130mm

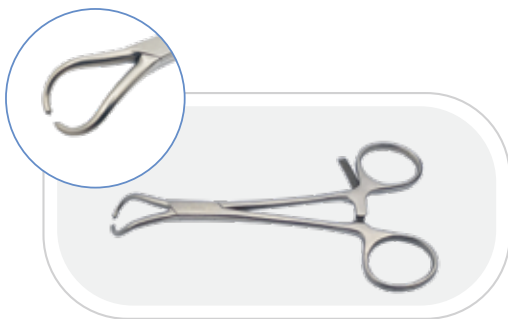

Mini Bone Forceps

Small Pointed Reduction Forceps With Ball Heads

Veterinary Use Only

Code	L
100303	135mm

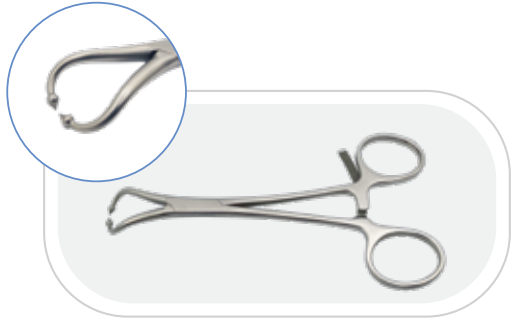

Mini Serrated Bone Holding Forceps

Veterinary Use Only

Code	Specification	L
100014	12mm	180mm
100015	7mm	140mm
100016	5mm	140mm
100017	3mm	140mm

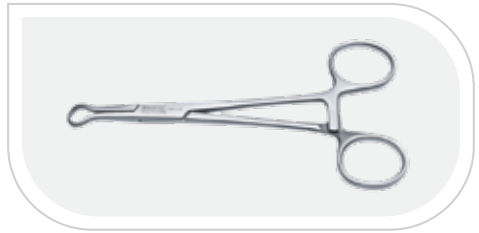

Soft Ratchet Reduction Forceps

Reduction Forceps with Serrated Jaws

Veterinary Use Only

Code	L
100008	150mm

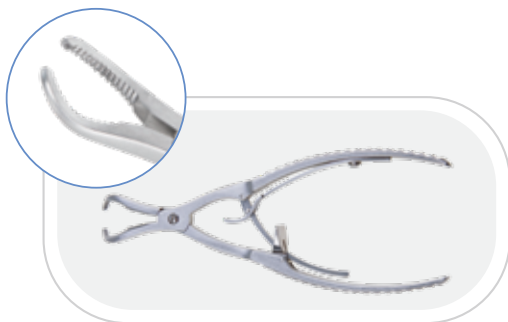

Reduction Forceps with Points

Veterinary Use Only

Code	L
100009	150mm



Reduction Forceps with small Point

Veterinary Use Only

Code	L
100009b	150mm

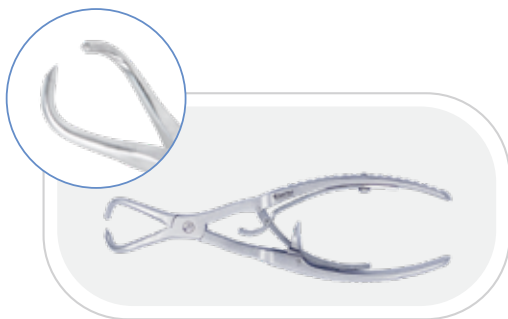

Soft Ratchet Reduction Forceps

Plate Holding Forceps

Veterinary Use Only

Code	L
100026b	160mm

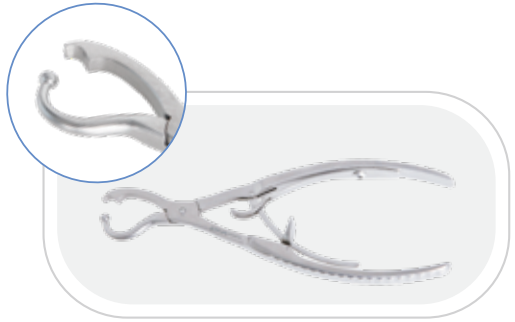

Bone Holding Forceps With Serrated Jaws/Spinlock

Veterinary Use Only

Code	L
100012	180mm
100013	205mm

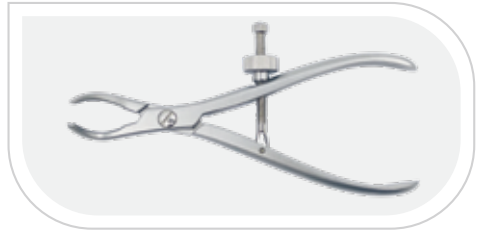

Small Curved Serrated Reduction Forceps

Veterinary Use Only

Code	L
100018	150mm



Soft Ratchet Reduction Forceps

Verbrugge Self Centering Bone Holding Forceps

Veterinary Use Only

Code	Specification	L
100019	Very Small	150mm
100020	Small	180mm
100021	Large	240mm



KERN Bone Holding Forceps

Veterinary Use Only

Code	Products Name	L
100022	MINI KERN Bone Holding Forceps	140mm
100023	KERN Bone Holding Forceps	180mm

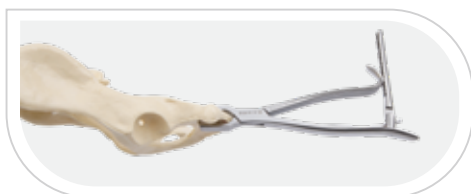

Temporary Reduction-Plate Holding Threaded Pins

Veterinary Use Only

Code	Specification
PRW125	1.25mm 3.5mm
PRW150	1.50mm 5.5mm

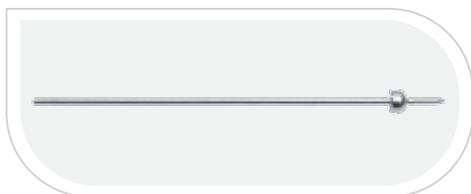

Soft Ratchet Reduction Forceps

Lowman Bone Clamp

Veterinary Use Only

Code	Products Name	Specification	L
100024	Lowman Bone Clamp<15mm	Small	80mm
100025	Lowman Bone Clamp<30mm	Large	120mm



Pointed Reduction Forceps With Spinlock

Veterinary Use Only

Code	Products Name	L
100010a	Pointed Reduction Forceps With Spinlock	180mm



Dr Vladislav Zlatinov



Plate Holding Forceps With Ball Heads

Veterinary Use Only

Code	L
100026a	160mm
100303	135mm

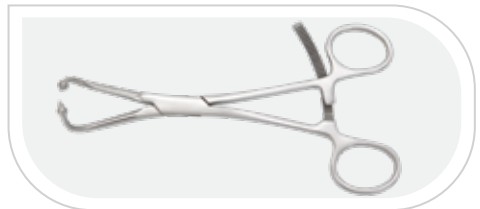

Implants Cutting Tools

Safety Rod Cutter

Veterinary Use Only

Code	Specification	L
100027	2.5/3.0/4.0mm	300mm



Implant Cutter Large

Veterinary Use Only

Code	Capacity	L
100028	6mm	530mm

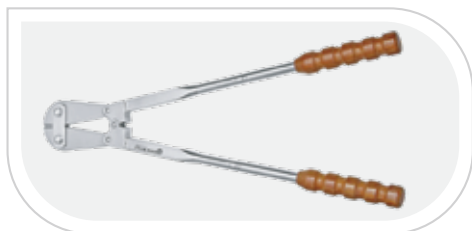
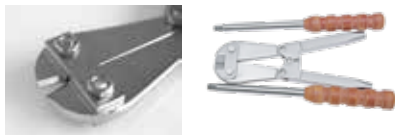

Implant Cutter Medium

Veterinary Use Only

Code	Capacity	L
110028	4mm	370mm



Implants Cutting Tools

Wire/Small Pin Cutter

Veterinary Use Only

Code	Capacity	L
100029	1.5mm	160mm

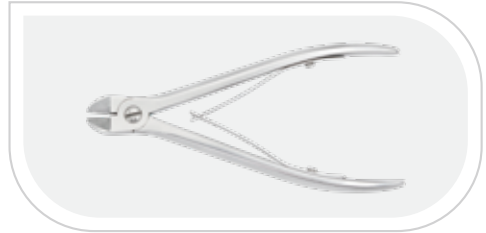

Safety Pin Cutter

Veterinary Use Only

Code	Capacity	L
100030	2.0/2.5/3.0mm	205mm



Safety Cut

Normal Cut



Safety Cut

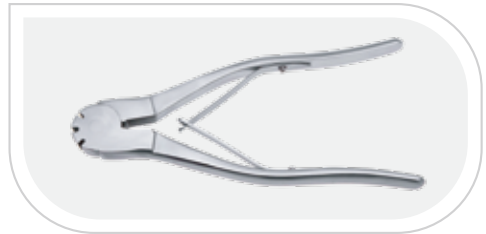

End Cutting Pliers

Veterinary Use Only

Code	Capacity	L
100031	2.5mm	235mm

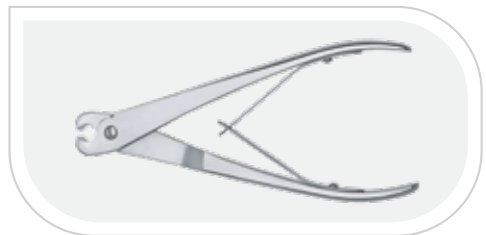

Implant Cutting Pliers

Veterinary Use Only

Code	Capacity	L
100032	2.5mm	210mm

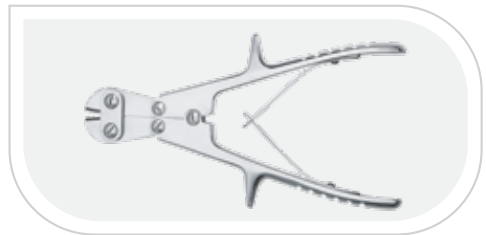

Implants Cutting Tools

Pin Pliers Modified Jaw/Flat Nose

Veterinary Use Only

Code	L
100033	220mm

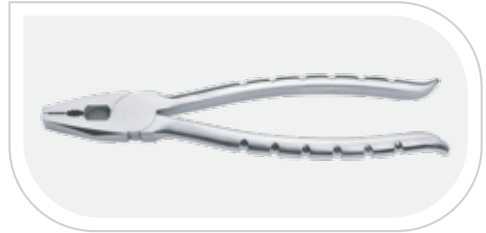
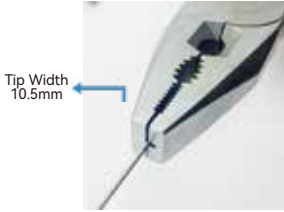

Pin Pliers Modified Jaw/Narrow Nose

Veterinary Use Only

Code	L
100034	200mm

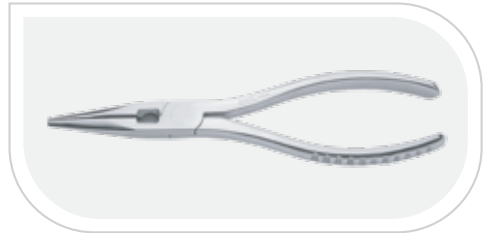

Small Pin/Wire Pliers

Veterinary Use Only

Code	L
100035	150mm

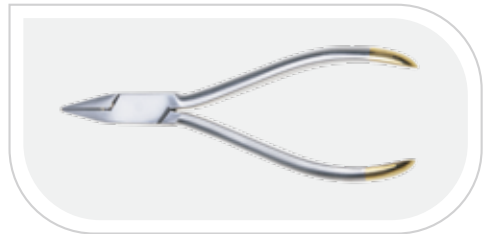

Implants Cutting Tools

Parallel Action Pliers

Veterinary Use Only

Code	L
100036	165mm

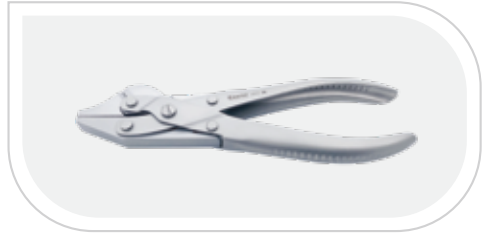

Multi-function Pin Pliers

Veterinary Use Only

Code	Specification	L
100091	2.5mm	200mm

Features dedicated three Kirschner wire cutting ports and three bending grooves, with a maximum cutting capacity ranging from 0 to 2.5 mm.

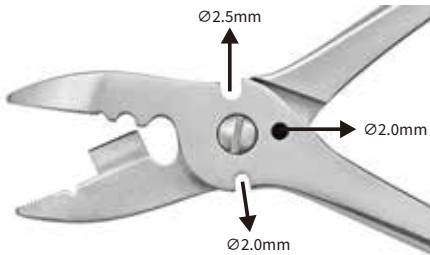

Wire/Small Pin Cutter

Veterinary Use Only

Code	Specification	L
100037	2.2mm	180mm

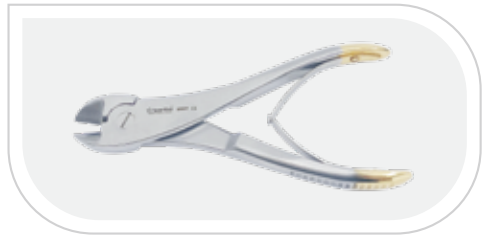

Implants Cutting Tools

Wire/Small Pin Cutter

Veterinary Use Only

Code	Capacity	L
110138	1.2mm	140mm

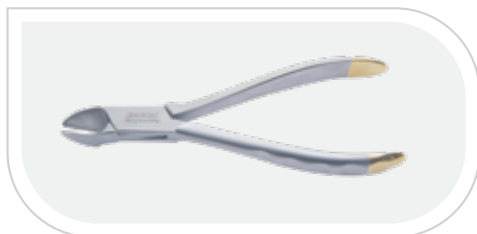

Plate/Pin Cutting Plier TC Gold

Veterinary Use Only

Code	Capacity	L
100038	2.8mm	230mm



Plate/Pin Cutting Plier TC Gold

Veterinary Use Only

Code	Capacity	L
100039	2.8mm	230mm
100040	2.2mm	170mm

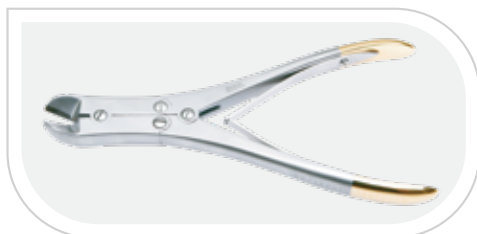

Implants Cutting Tools

Implant Cutter, Side And End Cutting, TC Gold

Veterinary Use Only

Code	Capacity	L
110039	1.8mm	180mm



Front End Wire Cutting Plier TC Gold

Veterinary Use Only

Code	Capacity	L
100041	2.8mm	230mm



Front End Wire Cutting Plier TC Gold

Veterinary Use Only

Code	Capacity	L
110041	1.5mm	160mm

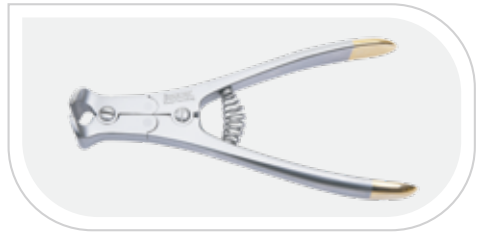

Implants Cutting Tools

Small Jacobs Chuck With Straight Handle

Veterinary Use Only

Code	Dia
100042	0-4mm



Jacobs Chuck With T Handle (Self-Lock)

Veterinary Use Only

Code	Dia
100043	0-6mm

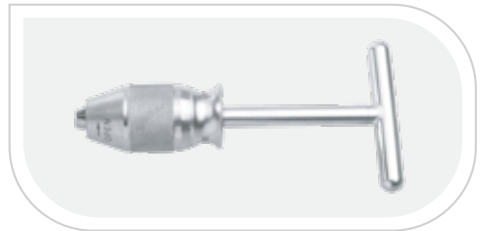

Jacobs Chuck With T Handle (Self-Lock)

Veterinary Use Only

Code	Dia
100044	0-6mm

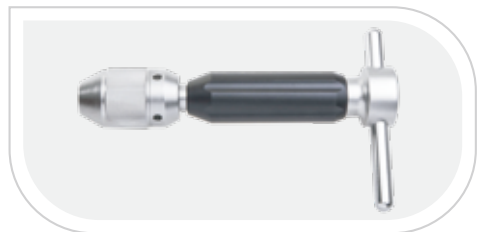

Osteotomes and Mallets

Osteotomes		Veterinary Use Only
Code	Specification	
100118	12mmX200mm	
100119	10mmX200mm	
100120	8mmX200mm	
100121	6mmX180mm	
100122	5mmX180mm	
110122	4mmX180mm	
110123	3mmX180mm	

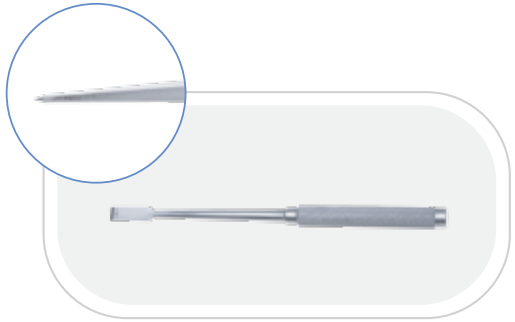

Chisels		Veterinary Use Only
Code	Specification	
100123	15mmX200mm	
100124	10mmX200mm	
100125	6mmX200mm	

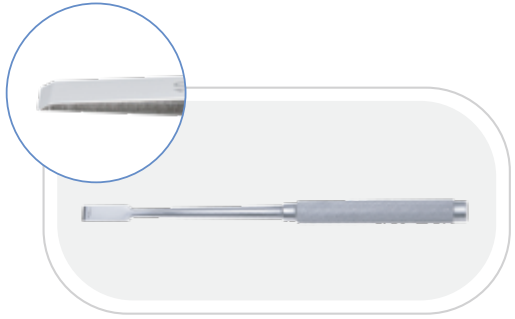

Trochlear Ultra-Thin Osteotomes		Veterinary Use Only
Code	Specification	
100126	2mm	
100127	3mm	
100128	4mm	
100112	6mm	
100113	8mm	



Osteotomes and Mallets

Modular Osteotomes Complete With 7 Blades

Veterinary Use Only

Code	Products Name	Specification
100103	Modular Osteotome With 7 Blades	Complete
	Modular Osteotome Replacement Blade	4mm
	Modular Osteotome Replacement Blade	6mm
	Modular Osteotome Replacement Blade	8mm
	Modular Osteotome Replacement Blade	10mm
	Modular Osteotome Replacement Blade	12mm
	Modular Osteotome Replacement Blade	15mm
	Modular Osteotome Replacement Blade	20mm



Orthopedic Mallet

Veterinary Use Only

Code	Specification
100059	150g
100060	270g
100061	350g

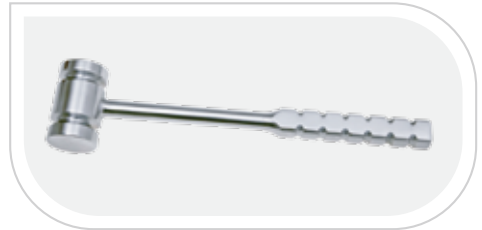

Bone Rasps

Veterinary Use Only

Code	Products Name	Width
100134	Curved Bone Rasp	5mm
100135	Straight Bone Rasp	5mm

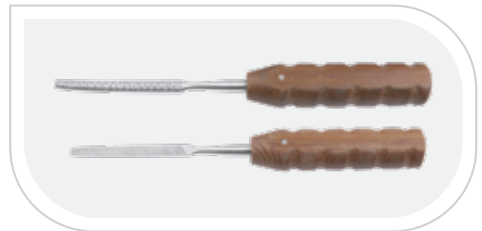

Osteotomes and Mallets

Double Rasps

Veterinary Use Only

Code	L
100131	185mm



Trochlea Rasps

Veterinary Use Only

Code	Specification	Dia	L
100132	Small	3.5mm	180mm
100133	Mini	2.2mm	180mm



Hand Saw

Veterinary Use Only

Code	SawBladeThickness	Depth	L
100130L	0.25mm	25mm	130mm



Trochleaplasty Bone Saw With Handle

Veterinary Use Only

Code	SawBladeThickness	Depth	L
100130S	0.25mm	15mm	70mm



Trochlear Sulcoplasty



Trochlear Sulcoplasty Instruments Set

Code	Products Name/Specification	Quantity
000001	Trochlear Sulcoplasty Instruments	
100130L	Sulcoplasty Bone Saw	1
100132	Trochlea Rasp Small 3.5mm	1
100133	Trochlea Rasp Mini 2.2mm	1
100126	Trochlear Ultra-Thin Osteotomes 2mm	1
100127	Trochlear Ultra-Thin Osteotomes 3mm	1
100128	Trochlear Ultra-Thin Osteotomes 4mm	1
100112	Trochlear Ultra-Thin Osteotomes 6mm	1
100113	Trochlear Ultra-Thin Osteotomes 8mm	1
100131S	180mm Straight Double Rasps	1
100131C	180mm Curved Double Rasps	1
100060	Orthopedic Mallet 270g	1
200099	Trochlear Sulcoplasty Instruments Case	1

Bone Curette

Walkman Spoon

Veterinary Use Only

Code	Head Width
100055	2mm
100056	3mm
100057	4mm
100058	5mm



Bone Curette

Veterinary Use Only

Code	Head Width	L
100195	3.0/3.5mm	13.5cm
100197	2.0/2.5mm	13.5cm



Hatt Spoon

Veterinary Use Only

Code	L
300005	280mm(20mmX30mm scoop)
300006	260mm(12mmX18mm scoop)
300007	230mm(8mmX12mm scoop)

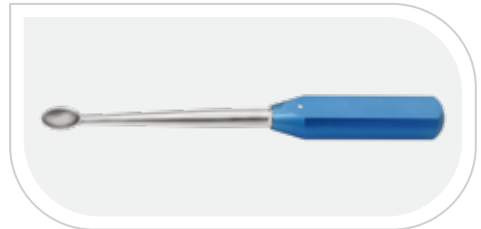

Meniscal Probe for Arthroscopy, Calibrated, 2mm

Veterinary Use Only

Code	L
100333	155mm

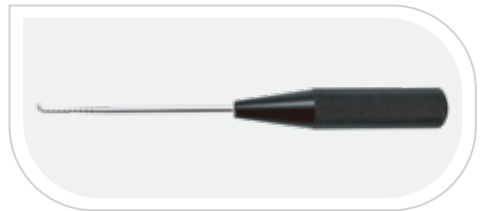

Periosteal Elevator

Mini Double End Periosteal Elevator

Veterinary
Use Only

Code	Head Width
100096	3mm
100097	5mm

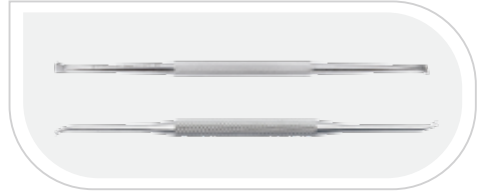

Periosteal Elevator

Veterinary
Use Only

Code	Head Width	Blade
110098	4mm	180mm
100099	6mm	180mm



Periosteal Elevator

Veterinary
Use Only

Code	Head Width	Blade
100098	6mm	180mm
100100	8mm	180mm



Hohman Retractor

Construction of Hohman Retractor

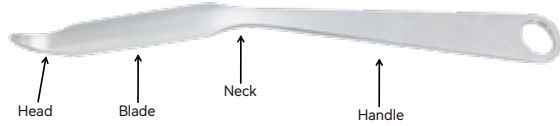

Mini Hohman Retractor Narrow Series

Veterinary Use Only

Code	Short Tip	L
100144	6mm	160mm
100145	8mm	160mm
100146	12mm	165mm
100315	10mm	160mm

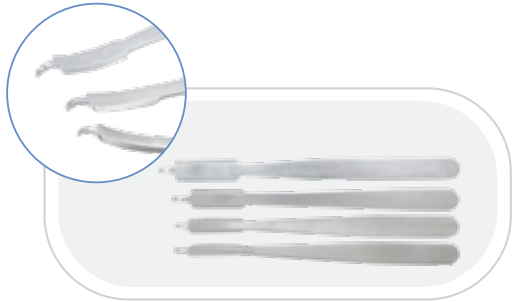

Mini Hohman Retractor Broad

Veterinary Use Only

Code	Short Tip	L
110146	15mm	165mm



Swan-Neck Hohman Reactor

Veterinary Use Only

Code	Blade
100138	20mm

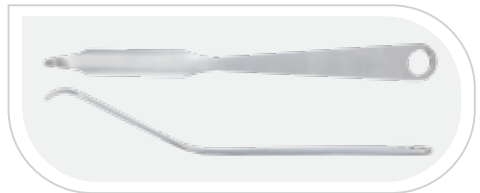

Hohman Retractor

Hip Retractors Series

Veterinary Use Only

Code	Specification
100139	Large 255mmX25mm
100140	Medium 180mmX13mm
100141	Small 130mmX8mm
100142	Mini 130mmX4mm



Hohman Retractor Broad

Veterinary Use Only

Code	Short Narrow Tip	L
100143	24mm	180mm



Hohman Retractor Broad With Double Tips

Veterinary Use Only

Code	Blade Width	Specification
100141b	20mm	155mmX10mmX20mm



Micro Hohman Retractor 4mm

Veterinary Use Only

Code	L
100147	175mm

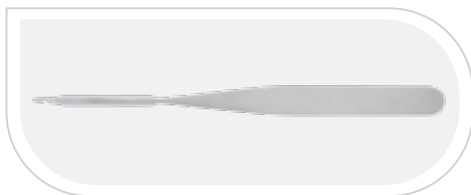

Bone Rongeur

Friedman Rongeur Curved

Veterinary Use Only

Code	Products Name	Bite	L
100078	Mini-Friedman Rongeur Curved	2mm	150mm
100079	Micro-Friedman Rongeur Curved	3mm	150mm
110079	Micro-Friedman Rongeur Angled	3mm	150mm
100080	Large-Friedman Rongeur Curved	5mm	180mm

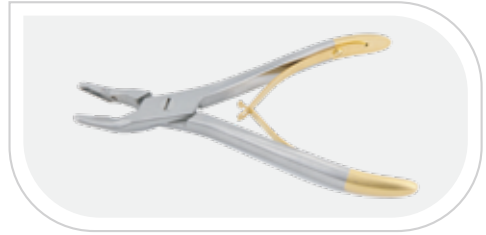

Lempert Rongeurs Straight

Veterinary Use Only

Code	Bite	L
110080	3mm	190mm

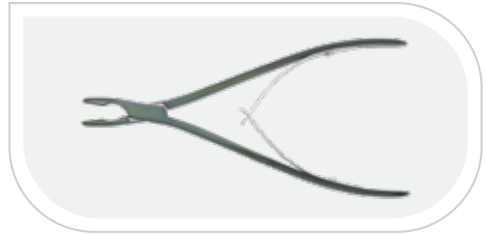

Double Joints Bone Rongeur

Jansen Double Joints Bone Rongeur

Veterinary Use Only

Code	Specification	Bite	L
100081	Curved	3mm	150mm
100082	Angled	4mm	150mm

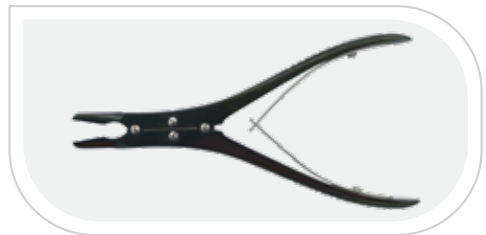

Ruskin (Liston) Rongeur Curved

Veterinary Use Only

Code	Bite	L
100083	2mm	160mm
100084	3mm	160mm
100085	5mm	180mm

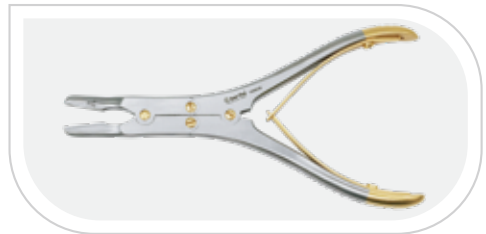

Double Joints Bone Rongeur

Double Joints Bone Rongeur Curved

Veterinary Use Only

Code	Bite	L
100086	8mm	230mm



Leksell Rongeur(Angled)

Veterinary Use Only

Code	Bite	L
100087	5mm	230mm
100088	8mm	230mm



Bone Cutters

Cleveland Angled Bone Cutter

Veterinary Use Only

Code	Blade	L
100089	15mm	150mm

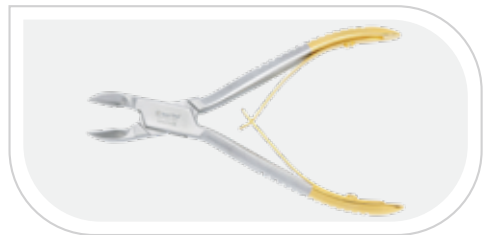

Liston Bone Cutters

Veterinary Use Only

Code	Specification	Blade	L
100090	Straight	25mm	180mm
110090	Curved	25mm	180mm

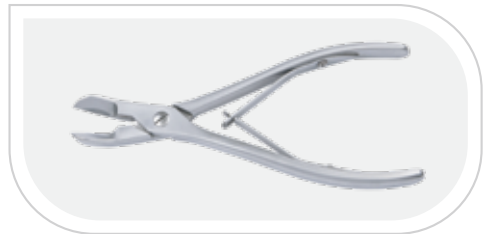

Bone Cutters

Littauer Bone Cutters

Veterinary Use Only

Code	Blade	L
100093	15mm	150mm

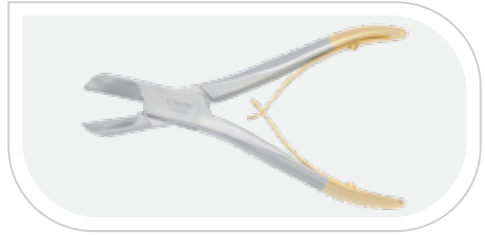

McIndoe Bone Cutter

Veterinary Use Only

Code	Blade	L
100092	12mm	150mm

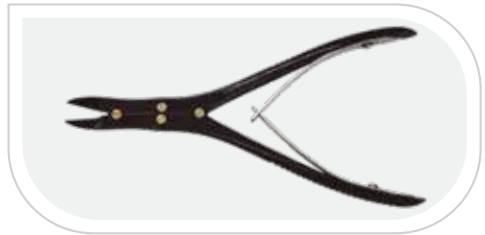

Horsley Bone Cutter

Veterinary Use Only

Code	Specification	Blade	L
100094	Straight	35mm	240mm
100095	Curved	35mm	240mm

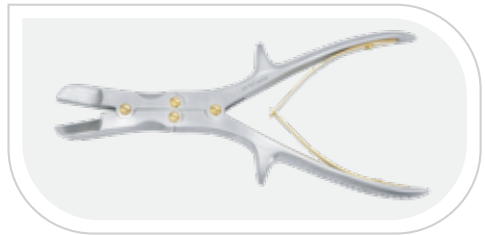

AO Quick Coupling Handle

T Shape Quick Couple Handle

Veterinary Use Only

Code	Used For	L
100159	2,4,2.7,3.5,4.0,4.5Taps	75mm



Straight Quick Couple Handle

Veterinary Use Only

Code	Specification	L
110160	Large	110mm
100160	Small	110mm



AO QCK / Jacob Converter

Veterinary Use Only

Code	Products Name
111160	AO QCK/Jacob Converter

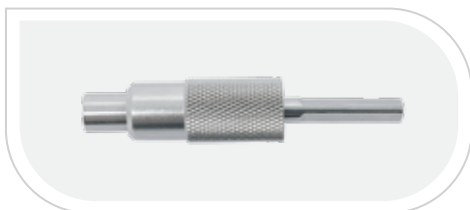

Screwdriver+Sleeves

Screwdriver For 1.5/2.0/2.4mm Screw		Veterinary Use Only
Code	Products Name	Specification
100217	Screw holding Sleeve	
100218	Hex Screwdriver with Fibre Handle	1.5mm
100219	Hex Screwdriver+Sleeve with Fibre Handle	1.5mm

Screwdriver+Sleeve For 1.5/2.0/2.4mm Screw.



Screwdriver For 2.7/3.0/3.5/4.0mm Screw		Veterinary Use Only
Code	Products Name	Specification
100220	Screw holding Sleeve	
100221	Hex Screwdriver with Fibre Handle	2.5mm
100222	Hex Screwdriver+Sleeve with Fibre Handle	2.5mm

Screwdriver+Sleeve For 2.7/3.0/3.5/4.0mm Screw.



Screwdriver For 4.5/6.0mm Screw		Veterinary Use Only
Code	Products Name	Specification
100223	Screw holding Sleeve	
100224	Hex Screwdriver with Fibre Handle	3.5mm
100225	Hex Screwdriver+Sleeve with Fibre Handle	3.5mm



Torx Type Screwdriver

Torx Type Screwdriver (Aluminum handle)

 Veterinary
Use Only

Code	Products Name	For Screw
920210	T6 Torx Type Screwdriver	TCS15/20B24CSTT20LS20
920209	T8 Torx Type Screwdriver	CSTT24/27 LS24/27
100258	T10 Torx Type Screwdriver	FKS30/35
920208	T15 Torx Type Screwdriver	CSTT35 LS35

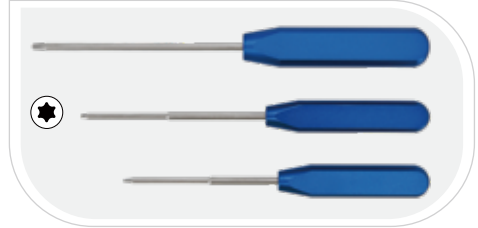

Quick Coupling Screwdriver

Quick Coupling Screwdriver

 Veterinary
Use Only

Code	Products Name	For Screw
100226	Hex Screwdriver AO QC1.5mm	CAN22/30
100227	Hex Screwdriver AO QC2.0mm	
100228	Hex Screwdriver AO QC2.5mm	CAN30/40
100229	Hex Screwdriver AO QC3.5mm	CSST45/55
100200	AO QC Square Head 1.2mm	
100201	AO QC Square Head 1.5mm	
100202	AO QC Square Head 2.0mm	



Torx Drive Screwdriver shaft

Torx Drive Screwdriver shaft

 Veterinary
Use Only

Code	Products Name	For Screw
100230	T15 Torx Drive Screwdriver shaft	A03.5mm Locking
100231	T8 Torx Drive Screwdriver shaft	A02.4/2.7mm Locking
100232	T6 Torx Drive Screwdriver shaft	A02.0mm, B2.4mm Locking
1002310	T10 Torx Drive Screwdriver shaft	B4.0mm Locking
110232	T4 Torx Drive Screwdriver shaft	A01.2/1.5mm Locking
110230	T25 Torx Drive Screwdriver shaft	A05.0mm Locking

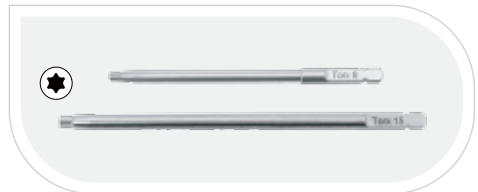

Drill Bits

Drill Bits			Veterinary Use Only
Code	Dia	L	
A32A08	0.8mm	65mm	
A32A10	1.0mm	65mm	
A32A11	1.1mm	85mm	
A32A12	1.2mm	85mm	
A32A15	1.5mm	125mm	
A32A18	1.8mm	150mm	
A32A20	2.0mm	150mm	
A32A24	2.4mm	150mm	
A32A25	2.5mm	150mm	
A32A27	2.7mm	150mm	
A32A28	2.8mm	150mm	
A32A30	3.0mm	150mm	
A32A32	3.2mm	150mm	
A32A35	3.5mm	150mm	
A32A40	4.0mm	150mm	



AO Style Quick Coupling Drill Bits			Veterinary Use Only
Code	Dia	L	
A32QC08	0.8mm	70mm	
A32QC11	1.1mm	85mm	
A32QC15	1.5mm	110mm	
A32QC18	1.8mm	125mm	
A32QC20	2.0mm	125mm	
A32QC24	2.4mm	125mm	
A32QC25	2.5mm	150mm	
A32QC27	2.7mm	150mm	
A32QC28	2.8mm	165mm	
A32QC32	3.2mm	150mm	
A32QC35	3.5mm	150mm	

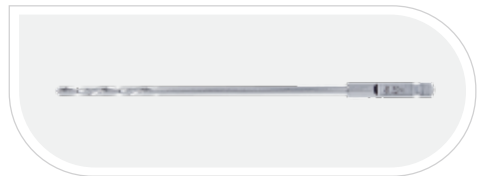

Drill Bits

Cannulated Drill Bits

Veterinary Use Only

Code	Products Name	OD	Guide Pin	L
A32CAN20	Cannulated Drills	2.0mm	1.0mm	150mm
A32CAN27	Cannulated Drills	2.7mm	1.2mm	150mm
A32CAN32	Cannulated Drills	3.2mm	1.5mm	150mm
A32CAN50	Cannulated Drills	5.0mm	2.5mm	250mm
A32CAN27QC	AO Cannulated Drills	2.7mm	1.5mm	160mm
A32CAN30	Cannulated Drills	3.0mm	1.5mm	130mm
A32CAN47	Cannulated Drills	4.7mm	3.2mm	300mm

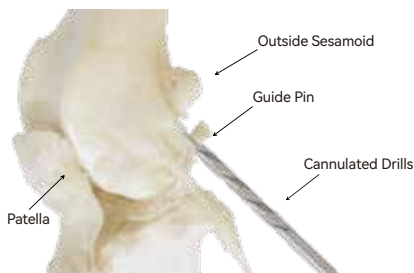
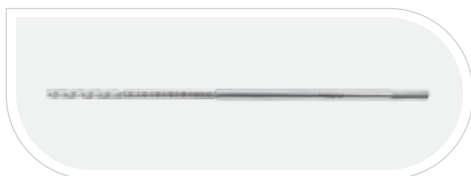

Countersink

Countersink AO Quick Fit Coupling

Veterinary Use Only

Code	Dia
100239b	Φ3mm
100240	Φ4mm
100241	Φ5mm
100242	Φ6mm



Countersink 'T' Handle

Veterinary Use Only

Code	Specification
100243	Mini 1.5/2.0/2.4mm
100244	Small 2.7/3.0/3.5/4.0mm
100245	Large 4.5/6.0mm

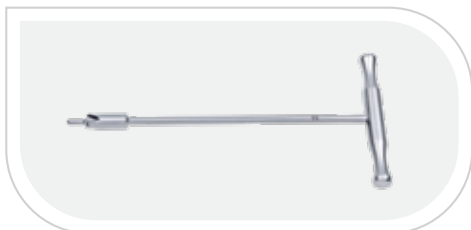

Taps

T Handle Taps			Veterinary Use Only
Code	Products Name	Specification	Screw Pitch
100161	T Handle Taps Cortical	1.5mm	
100162	T Handle Taps Cortical	2.0mm	0.6mm
100163	T Handle Taps Cancellous	2.2mm	1.0mm
100164	T Handle Taps Cortical	2.4mm	
100165	T Handle Taps Cortical	2.7mm	
100166	T Handle Taps Cortical	3.5mm	
100167	T Handle Taps Cancellous	4.0mm	
100168	T Handle Taps Cortical	4.5mm	
100169	T Handle Taps Cancellous	6.5mm	



AO Quick Coupling Taps			Veterinary Use Only
Code	Products Name	Specification	
100170	AO Quick Coupling Taps Cortical	1.5mm	
100171	AO Quick Coupling Taps Cortical	2.0mm	
100172	AO Quick Coupling Taps Cortical	2.4mm	
100173	AO Quick Coupling Taps Cortical	2.7mm	
100174	AO Quick Coupling Taps Cortical	3.5mm	
100175	AO Quick Coupling Taps Cancellous	4.0mm	
100176	AO Quick Coupling Taps Cortical	4.5mm	
100177	AO Quick Coupling Taps Cancellous	6.5mm	



Drill Guides

Double Drill Guide

Veterinary Use Only

Code	Specification
100187	0.8/1.1mm
100178	1.1/1.5mm
100179	1.5/2.0mm
100180	1.8/2.4mm
100181	2.0/2.7mm
100182	2.5/3.5mm
100183	3.2/4.5mm



Universal Drill Guide

Veterinary Use Only

Code	Specification
100188	1.5/2.0mm
100189	1.8/2.4mm
100190	2.0/2.7mm
100191	2.5/3.5mm



Parallel Drill Guide

Veterinary Use Only

Code	For Drill Bits
100192	2.0mm
100194	1.5mm



Aiming Drill Guide

Veterinary Use Only

Code	Specification	Inner Dia	L
100206	Small	3.5mm	135mm



Drill Guides

Load And Neutral Drill Guides For LC-DCP And DCP		Veterinary Use Only
Code	Used For	
100211	2.0mm Compression Plates	
100212	2.4mm Compression Plates	
100213	2.7mm Compression Plates	
100215	3.5mm Compression Plates	
100216	4.5mm Compression Plates	

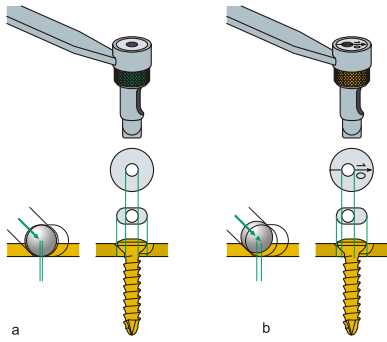

The application of the drill guide depends on the function which the screw should have:
 a Neutral position (green end of guide)
 b Compression mode (gold end of the guide)

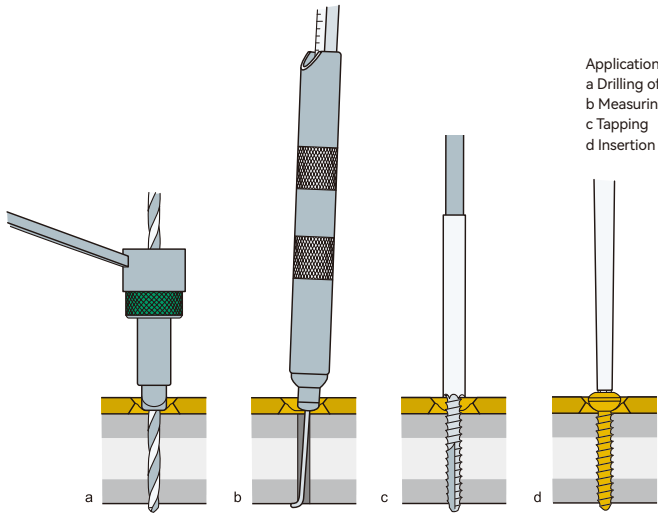

Application of a plate screw:
 a Drilling of the hole in neutral position
 b Measuring the hole length
 c Tapping
 d Insertion of the screw

Depth Gauge

Depth Gauge			Veterinary Use Only
Code	For Screws	Range	
100236	1.5mm/2.0mm	0-30mm	
100237	2.4mm/2.7mm	0-50mm	
100238	3.5mm/4.0mm	0-60mm	
100239	4.5mm/6.0mm	0-90mm	

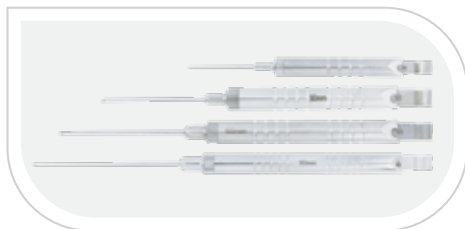

Three Scales Depth Gauge			Veterinary Use Only
Code	For Screws	Range	
100336	1.5mm/2.0mm/2.4mm	0-30mm	
100337	2.7mm/3.5mm	0-50mm	

Precise screw measurement is important in Small Animal surgery. To accommodate your preference, the depth gauges can be utilized in a single or two-handed mode. Also for your convenience, it has three scales which you can read from for your measurement.

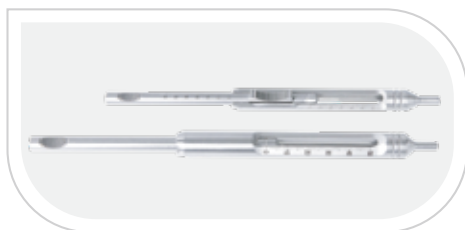

Screw Holding Forceps		Veterinary Use Only
Code	Specification	
100233	2.7/3.0/3.5/4.0mm	
100234	1.5/2.0/2.4mm	
100235	4.5/6.0mm	

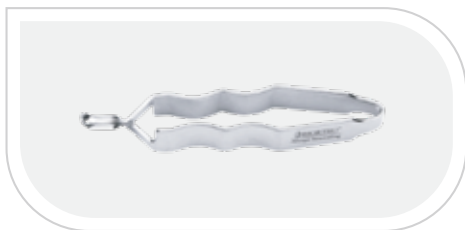

Bone Plate Template

Bone Plate Template			Veterinary Use Only
Code	Wide	Use For	
100309	4.0mm	1.5mm LCP	
100310	5.0mm	2.0mm LCP	
100311	6.5mm	2.4mm LCP	
100312	8.0mm	2.7mm LCP	
100313	11.0mm	Narrow 3.5mm LCP	
100314	13.5mm	Broad 3.5mm LCP	

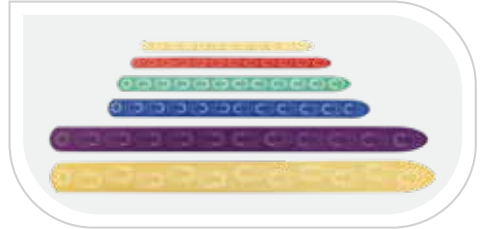

Bending Irons

Bending Irons Small			Veterinary Use Only
Code	Specification	L	
100066	A02.7/3.5mm	175mm	

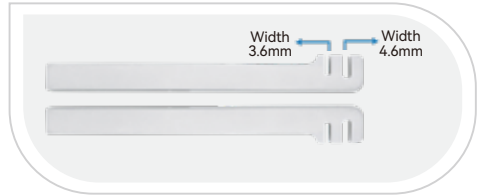

Bending Irons Large			Veterinary Use Only
Code	Specification	L	
100067	A03.5/4.5mm	270mm	

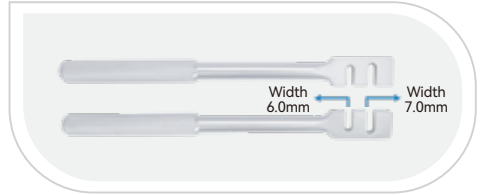

Reconstruction Bending Irons

Reconstruction Type Bending Irons (Pair)			Veterinary Use Only
Code	Specification	L	
100070	BW 3.5mm	200mm	

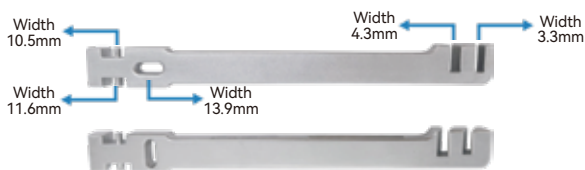

3.5mm Reconstruction Plate Plier			Veterinary Use Only
Code	Specification	L	
100071	3.5mm	280mm	



Reconstruction Bending Irons

Plate Bending Plier Roller Type

Veterinary Use Only

Code	Specification	L
100072	10.0/11.0	230mm
100072S	5.0/6.5/8.0/9.0	210mm

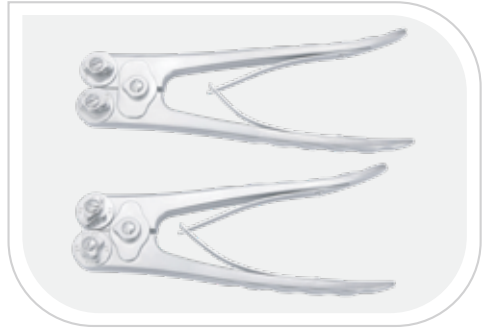
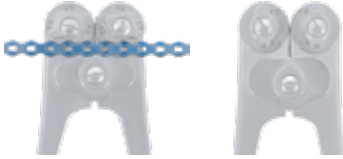

Reconstruction Plate Bender

Veterinary Use Only

Code	Products Name
100073	Reconstruction Plate Bender



Bone Plate Bending Press Heavy Duty

Veterinary Use Only

Code	Products Name
100076	Bone Plate Bending Press Heavy Duty



Drill Bits

Screw Extractor

Veterinary Use Only

Code	Specification
100256	SW2.5/T10
100255	SW1.5/T8
100254	SW1.2/T6
100253	SW3.5mm



High Speed Drill Bit For Implant Metal

Veterinary Use Only

Code	Products Name
100327	High Speed Drill Bit For Implant Metal 3
100328	High Speed Drill Bit For Implant Metal 4
100329	High Speed Drill Bit For Implant Metal 5

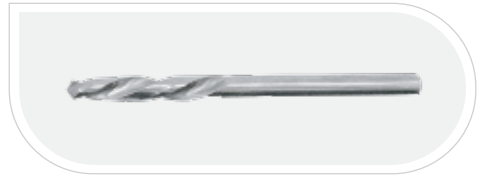

Extraction Trephine

Veterinary Use Only

Code	For Screws
100246	1.5mm
100247	2.0mm
100248	2.4mm
100249	2.7mm
100250	3.5mm
100251	4.0mm

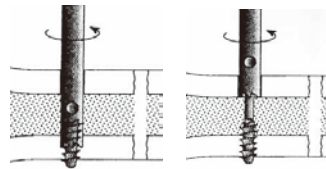

Small Animal Implants Removal Set



Small Animal Implants Removal Set

Code	Products Name/Specification	Quantity
100160	AO Quick Coupling Handle 110mm	1
100035	Small Pin Plier 150mm	1
100246	Extraction Trephine,For 1.5 Screws	1
100247	Extraction Trephine,For 2.0 Screws	1
100248	Extraction Trephine,For 2.4 Screws	1
100249	Extraction Trephine,For 2.7 Screws	1
100250	Extraction Trephine,For 3.5 Screws	1
100251	Extraction Trephine,For 4.0 Screws	1
100200	AO QC Square Head 1.2mm	1
100201	AO QC Square Head 1.5mm	1
100232	T6 Star Drive Screwdriver shaft	1
100231	T8 Star Drive Screwdriver shaft	1
100230	T15 Star Drive Screwdriver shaft	1
1002310	T10 Star Drive Screwdriver shaft	1
100226	Hex Screwdriver AO QC1.5mm	1
100228	Hex Screwdriver AO QC2.5mm	1
100254	AO Screw Extractor SW1.2/T6	1
100255	AO Screw Extractor SW1.5/T8	1
100256	AO Screw Extractor SW2.5/T10	1
100253	AO Screw Extractor SW3.5mm	1
100327	High Speed Drill Bit 3	1
100328	High Speed Drill Bit 4	1
100329	High Speed Drill Bit 5	1
100330	Small Animal Implants Removal Box	1

Bone Models & Pre-Operative Planing



Bone Models

Tibia Model

Veterinary
Use Only

Code	L
M0001	250mm



Ulna Model

Veterinary
Use Only

Code	L
M0002	170mm



Radius Model

Veterinary
Use Only

Code	L
M0003	170mm



Pelvis Model Full

Veterinary
Use Only

Code	L
M0024	175mm

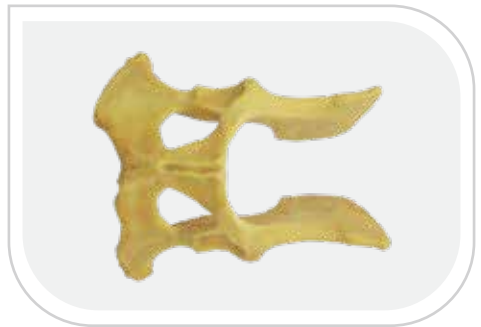

Bone Models

Femur Model

Veterinary
Use Only

Code	L
M0005	210mm



Humerus Model

Veterinary
Use Only

Code	L
M0006	170mm



Tubular model

Veterinary
Use Only

Code	L
M0012	180mm



Bone Models

Scapula Model

Veterinary
Use Only

Code	L
M0028	110mm



Posterior Limb+Pelvis+Hip Joint

Veterinary
Use Only

Code
N0001



Femur Model

Veterinary
Use Only

Code	L
N0002	78mm



Pelvis Model

Veterinary
Use Only

Code
N0003

A 3D rendered model of a pelvis bone, shown in a light yellow color. The model shows the two halves of the pelvis joined together, with the iliac, ischial, and pubic bones visible. It is displayed against a light gray background within a white rounded rectangular frame.

Bone Models

Radioulna Model

Veterinary
Use Only

Code	L
N0004	80mm



Humerus Model

Veterinary
Use Only

Code	L
N0005	72mm



Tibia Model

Veterinary
Use Only

Code	L
N0006	75mm



Anterior limb Model

Veterinary
Use Only

Code	L
N0007	



Bone Models

Knee-joint Model

Veterinary
Use Only

Code

N0008



Skull Model

Veterinary
Use Only

Code

M0014



Spine Model

Veterinary
Use Only

Code

L0002



Bone Models

Anterior Limb Model

Veterinary
Use Only

Code

L0004



Posterior Limb Model

Veterinary
Use Only

Code

L0003



Horse Hoof Model

Veterinary
Use Only

Code

L0005



Pre Operative Planing Tools

Surgical Measuring Ruler With Gauge Holes

Veterinary Use Only

Code	L
M0009	100mm



X Ray Reference Ball

Veterinary Use Only

Code	Specification	Dia
M0011	Single Ball	25mm
M0011X	Double Balls	10/20mm

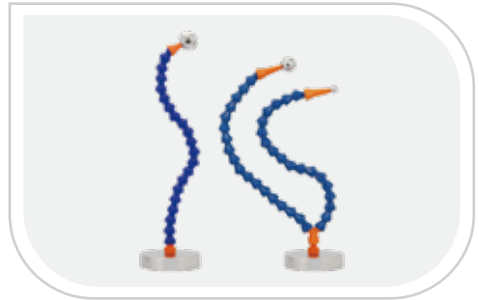

Orthopedic Surgery Planing Ruler

Veterinary Use Only

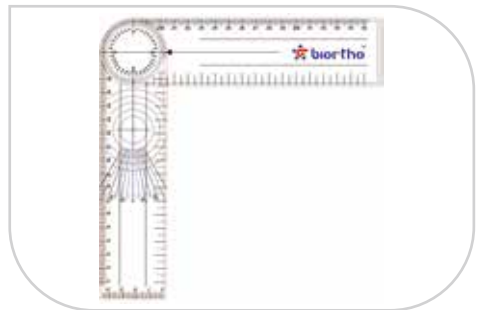

Code	L
M0010	360mm

















Veterinary Orthopaedic Screws



Standard Screws, Drill Bits and Taps for Veterinary Use

SCREW DIAMETER (mm)							
Thread Diameter	1.5	2.0	2.4	2.7	3.5	4.5	5.5
Screw Type	Cortex						
Vet Part Number Self-Tapping None-Self-Tapping	CSTT1505- CSTT1520	CSTT2006- CSTT2026	CSTT2408- CSTT2430	CSTT2708- CSTT2740	CSTT3510- CSTT3560	CSST4520- CSST4580	CSST5524- CSST55100
DRILL BIT and TAP DIAMETER(mm)							
Drill Bit for Gliding Hole	1.5	2.0	2.4	2.7	3.5	4.5	5.5
GLIDING HOLE							
THREADED HOLE							
Drill Bit for Threaded Hole	1.1	1.5	1.8	2.0	2.5	3.2	4.0
Tap Catalog Number	1.5 (100161)	2.0 (100162)	2.4 (100164)	2.7 (100165)	3.5 (100166)	4.5 (100168)	5.5
Drive Type	T6 Torx	T6 Torx	T8 Torx	T8 Torx	T15 Torx	3.5mm Hexagonal	3.5mm Hexagonal

Locking Screws and Drill Bits for Veterinary Use SCREW DIAMETER(mm)

SCREW DIAMETER (mm)							
Thread Diameter	1.5	2.0	2.4	2.7	3.0	3.5	5.0
Screw Type	Locking Head						
Vet Part Number None-Self-Tapping	LS1505- LS1520	LS2006- LS2026	LS2408- LS2430	LS2710- LS2734	LS3010- LS3040	LS3510- LS3560	LS5014- LS5090
DRILL BIT DIAMETER(mm)							
							
							
Drill Bit for Threaded Hole	1.1	1.5	1.8	2.0	2.5	2.8	4.3
Drive Type	T4 Torx	T6 Torx	T8 Torx	T8 Torx	T10 Torx	T15 Torx	T25 Torx

Cortex Screws

1.5mm Cortex Self Tapping Screws

Veterinary Use Only Stainless Steel 316LVM

Code	L	Code	L
VS105.05	5mm	VS105.13	13mm
VS105.06	6mm	VS105.14	14mm
VS105.07	7mm	VS105.16	16mm
VS105.08	8mm	VS105.18	18mm
VS105.09	9mm	VS105.20	20mm
VS105.10	10mm	VS105.22	22mm
VS105.11	11mm	VS105.24	24mm
VS105.12	12mm		

● T4 Torx

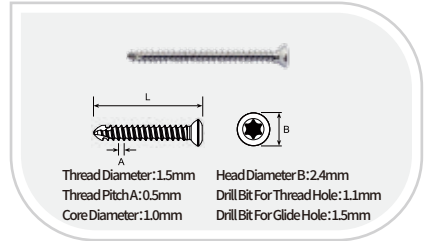

1.5mm Cortex Self Tapping Screws

Veterinary Use Only Stainless Steel 316LVM

Code	L	Code	L
CSTT1505	5mm	CSTT1512	12mm
CSTT1506	6mm	CSTT1514	14mm
CSTT1507	7mm	CSTT1516	16mm
CSTT1508	8mm	CSTT1518	18mm
CSTT1510	10mm	CSTT1520	20mm

● T6 Torx

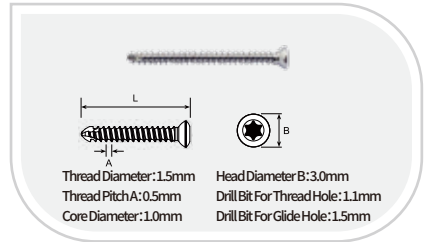

2.0mm Cortex Self Tapping Screws

Veterinary Use Only Stainless Steel 316LVM

Code	L	Code	L
CSTT2006	6mm	CSTT2016	16mm
CSTT2007	7mm	CSTT2018	18mm
CSTT2008	8mm	CSTT2020	20mm
CSTT2009	9mm	CSTT2022	22mm
CSTT2010	10mm	CSTT2024	24mm
CSTT2012	12mm	CSTT2026	26mm
CSTT2014	14mm		

● T6 Torx

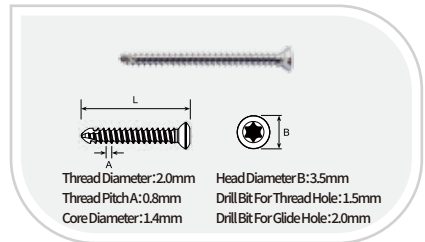

Cortex Screws

2.4mm Cortex Self Tapping Screws		Veterinary Use Only	Stainless Steel 316LVM
Code	L	Code	L
CSTT2406	6mm	CSTT2422	22mm
CSTT2408	8mm	CSTT2424	24mm
CSTT2410	10mm	CSTT2426	26mm
CSTT2411	11mm	CSTT2428	28mm
CSTT2412	12mm	CSTT2430	30mm
CSTT2413	13mm	CSTT2432	32mm
CSTT2414	14mm	CSTT2434	34mm
CSTT2416	16mm	CSTT2436	36mm
CSTT2418	18mm	CSTT2438	38mm
CSTT2420	20mm	CSTT2440	40mm

● T8 Torx

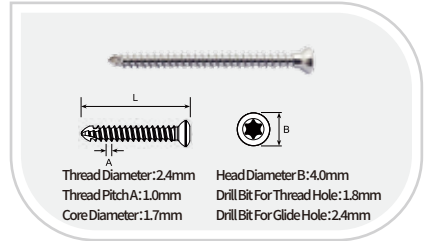

2.7mm Cortex Self Tapping Screws		Veterinary Use Only	Stainless Steel 316LVM
Code	L	Code	L
CSTT2708	8mm	CSTT2730	30mm
CSTT2710	10mm	CSTT2732	32mm
CSTT2712	12mm	CSTT2734	34mm
CSTT2714	14mm	CSTT2736	36mm
CSTT2716	16mm	CSTT2738	38mm
CSTT2718	18mm	CSTT2740	40mm
CSTT2720	20mm	CSTT2742	42mm
CSTT2722	22mm	CSTT2744	44mm
CSTT2724	24mm	CSTT2746	46mm
CSTT2726	26mm	CSTT2748	48mm
CSTT2728	28mm	CSTT2750	50mm

● T8 Torx

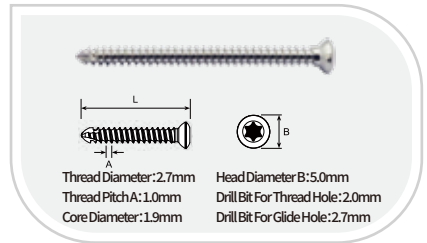

3.5mm Cortex Self Tapping Screws		Veterinary Use Only	Stainless Steel 316LVM
Code	L	Code	L
CSTT3510	10mm	CSTT3534	34mm
CSTT3512	12mm	CSTT3536	36mm
CSTT3514	14mm	CSTT3538	38mm
CSTT3516	16mm	CSTT3540	40mm
CSTT3518	18mm	CSTT3542	42mm
CSTT3520	20mm	CSTT3544	44mm
CSTT3522	22mm	CSTT3545	45mm
CSTT3524	24mm	CSTT3546	46mm
CSTT3526	26mm	CSTT3548	48mm
CSTT3528	28mm	CSTT3550	50mm
CSTT3530	30mm	CSTT3555	55mm
CSTT3532	32mm	CSTT3560	60mm

● T15 Torx

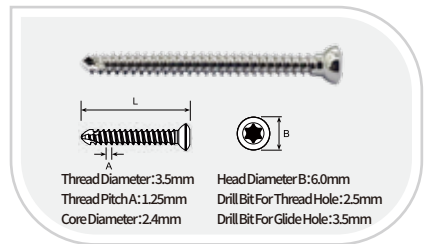

Cortex Screws

4.5mm Cortex Self Tapping Screws		Veterinary Use Only	Stainless Steel 316LVM
Code	L	Code	L
CSST4520	20mm	CSST4546	46mm
CSST4522	22mm	CSST4548	48mm
CSST4524	24mm	CSST4550	50mm
CSST4526	26mm	CSST4552	52mm
CSST4528	28mm	CSST4554	54mm
CSST4530	30mm	CSST4556	56mm
CSST4532	32mm	CSST4558	58mm
CSST4534	34mm	CSST4560	60mm
CSST4536	36mm	CSST4565	65mm
CSST4538	38mm	CSST4570	70mm
CSST4540	40mm	CSST4575	75mm
CSST4542	42mm	CSST4580	80mm
CSST4544	44mm		

● 3.5mm Hexagonal

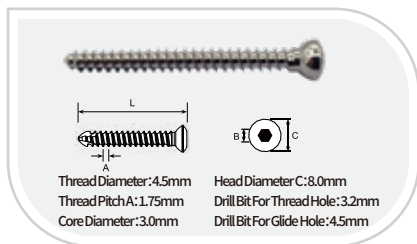

5.5mm Cortex Self Tapping Screws		Veterinary Use Only	Stainless Steel 316LVM
Code	L	Code	L
CSST5524	24mm	CSST5548	48mm
CSST5526	26mm	CSST5550	50mm
CSST5528	28mm	CSST5552	52mm
CSST5530	30mm	CSST5554	54mm
CSST5532	32mm	CSST5556	56mm
CSST5534	34mm	CSST5558	58mm
CSST5536	36mm	CSST5560	60mm
CSST5538	38mm	CSST5564	64mm
CSST5540	40mm	CSST5570	70mm
CSST5542	42mm	CSST5580	80mm
CSST5544	44mm	CSST5590	90mm
CSST5546	46mm	CSST55100	100mm

● 3.5mm Hexagonal

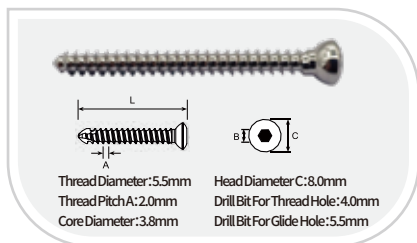

Cancellous Screws

2.2mm Cancellous Screws		Veterinary Use Only	Stainless Steel 316LVM
Code	L	Code	L
CAN2206	6mm	CAN2218	18mm
CAN2208	8mm	CAN2220	20mm
CAN2210	10mm	CAN2222	22mm
CAN2212	12mm	CAN2224	24mm
CAN2214	14mm	CAN2226	26mm
CAN2216	16mm	CAN2228	28mm

- Full Thread, 1.5mm Hexagonal

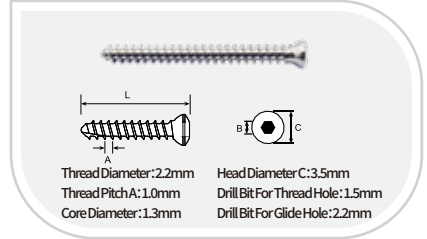

2.2mm Titanium Cancellous Screws		Veterinary Use Only	Titanium Grade 5
Code	L	Code	L
CAN2212T	12mm	CAN2222T	22mm
CAN2214T	14mm	CAN2224T	24mm
CAN2216T	16mm	CAN2226T	26mm
CAN2218T	18mm	CAN2228T	28mm
CAN2220T	20mm	CAN2230T	30mm

- 1/3 Partial Thread, T6 Torx

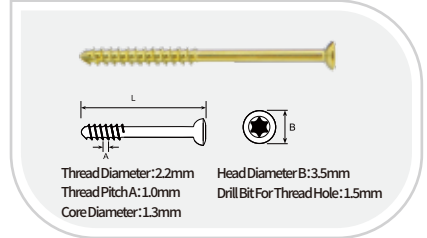

3.0mm Cancellous Screws		Veterinary Use Only	Stainless Steel 316LVM
Code	L	Code	L
CAN3010	10mm	CAN3024	24mm
CAN3012	12mm	CAN3026	26mm
CAN3014	14mm	CAN3028	28mm
CAN3016	16mm	CAN3030	30mm
CAN3018	18mm	CAN3032	32mm
CAN3020	20mm	CAN3034	34mm
CAN3022	22mm	CAN3036	36mm

- Full Thread, 2.5mm Hexagonal

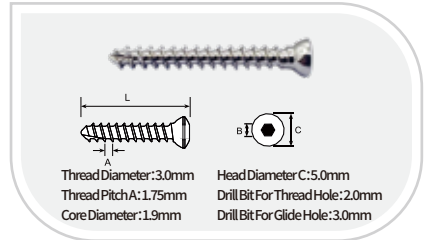

3.0mm Cancellous Screws		Veterinary Use Only	Stainless Steel 316LVM
Code	L	Code	L
CAN3016H	16mm	CAN3030H	30mm
CAN3018H	18mm	CAN3032H	32mm
CAN3020H	20mm	CAN3034H	34mm
CAN3022H	22mm	CAN3036H	36mm
CAN3024H	24mm	CAN3038H	38mm
CAN3026H	26mm	CAN3040H	40mm
CAN3028H	28mm	CAN3045H	45mm

- 1/3 Partial Thread, 2.5mm Hexagonal

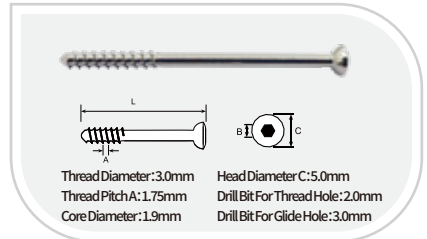

Cancellous Screws

4.0mm Cancellous Screws		Veterinary Use Only	Stainless Steel 316LVM
Code	L	Code	L
CNF4014	14mm	CNF4028	28mm
CNF4016	16mm	CNF4030	30mm
CNF4018	18mm	CNF4035	35mm
CNF4020	20mm	CNF4040	40mm
CNF4022	22mm	CNF4045	45mm
CNF4024	24mm	CNF4050	50mm
CNF4026	26mm		

- Full Thread, 2.5mm Hexagonal

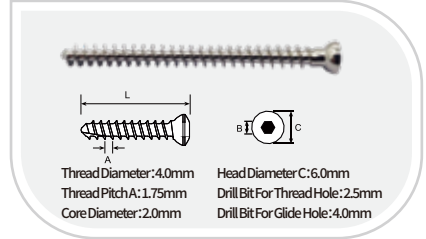

Washers		Veterinary Use Only	Stainless Steel 316LVM
Code	For Screws	Texture	Specs
PW1115	1.1mm/1.5mm	Stainless	2-Pack
PW1520	1.5mm/2.0mm	Stainless	2-Pack
PW2224	2.2mm/2.4mm	Stainless	1-Pack
PW2730	2.7mm/3.0mm	Stainless	1-Pack
PW3540	3.5mm/4.0mm	Stainless	1-Pack



AO Standard Locking Screw

1.5mm Locking Self Tapping Screws		Veterinary Use Only	Stainless Steel 316LVM
Code	L	Code	L
LS1505	5mm	LS1513	13mm
LS1506	6mm	LS1514	14mm
LS1507	7mm	LS1516	16mm
LS1508	8mm	LS1518	18mm
LS1509	9mm	LS1520	20mm
LS1510	10mm	LS1522	22mm
LS1511	11mm	LS1524	24mm
LS1512	12mm		

● T4 Torx

2.0mm Locking Self Tapping Screws		Veterinary Use Only	Stainless Steel 316LVM
Code	L	Code	L
LS2006	6mm	LS2016	16mm
LS2007	7mm	LS2018	18mm
LS2008	8mm	LS2020	20mm
LS2009	9mm	LS2022	22mm
LS2010	10mm	LS2024	24mm
LS2011	11mm	LS2026	26mm
LS2012	12mm	LS2028	28mm
LS2013	13mm	LS2030	30mm
LS2014	14mm		

● T6 Torx

2.4mm Locking Self Tapping Screws		Veterinary Use Only	Stainless Steel 316LVM
Code	L	Code	L
LS2406	6mm	LS2422	22mm
LS2408	8mm	LS2424	24mm
LS2410	10mm	LS2426	26mm
LS2411	11mm	LS2428	28mm
LS2412	12mm	LS2430	30mm
LS2413	13mm	LS2432	32mm
LS2414	14mm	LS2434	34mm
LS2416	16mm	LS2436	36mm
LS2418	18mm	LS2438	38mm
LS2420	20mm	LS2440	40mm

● T8 Torx

2.7mm Locking Self Tapping Screws		Veterinary Use Only	Stainless Steel 316LVM
Code	L	Code	L
LS2708	8mm	LS2726	26mm
LS2710	10mm	LS2728	28mm
LS2712	12mm	LS2730	30mm
LS2714	14mm	LS2732	32mm
LS2716	16mm	LS2734	34mm
LS2718	18mm	LS2736	36mm
LS2720	20mm	LS2738	38mm
LS2722	22mm	LS2740	40mm
LS2724	24mm		

● T8 Torx

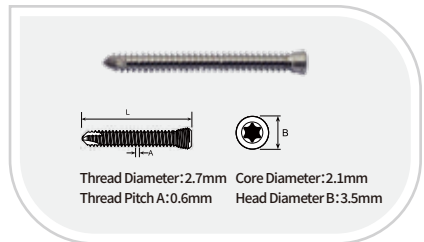
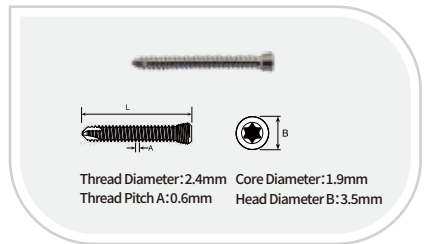
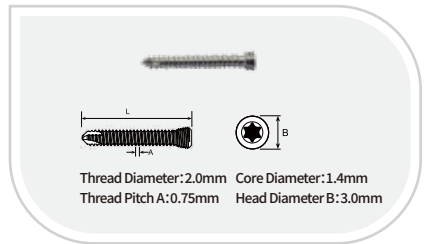
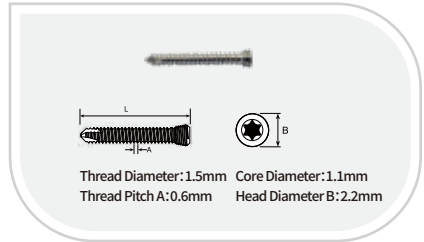

AO Standard Locking Screw

3.0mm Locking Self Tapping Screws

Veterinary Use Only Stainless Steel 316LVM

Code	L	Code	L
LS3010	10mm	LS3026	26mm
LS3012	12mm	LS3028	28mm
LS3014	14mm	LS3030	30mm
LS3016	16mm	LS3032	32mm
LS3018	18mm	LS3034	34mm
LS3020	20mm	LS3036	36mm
LS3022	22mm	LS3038	38mm
LS3024	24mm	LS3040	40mm

● T10 Torx

3.5mm Locking Self Tapping Screws

Veterinary Use Only Stainless Steel 316LVM

Code	L	Code	L
LS3510	10mm	LS3534	34mm
LS3512	12mm	LS3536	36mm
LS3514	14mm	LS3538	38mm
LS3516	16mm	LS3540	40mm
LS3518	18mm	LS3542	42mm
LS3520	20mm	LS3544	44mm
LS3522	22mm	LS3546	46mm
LS3524	24mm	LS3548	48mm
LS3526	26mm	LS3550	50mm
LS3528	28mm	LS3555	55mm
LS3530	30mm	LS3560	60mm
LS3532	32mm		

● T15 Torx

5.0mm Locking Self Tapping Screws

Veterinary Use Only Stainless Steel 316LVM

Code	L	Code	L
LS5014	14mm	LS5042	42mm
LS5016	16mm	LS5044	44mm
LS5018	18mm	LS5046	46mm
LS5020	20mm	LS5048	48mm
LS5022	22mm	LS5050	50mm
LS5024	24mm	LS5055	55mm
LS5026	26mm	LS5060	60mm
LS5028	28mm	LS5065	65mm
LS5030	30mm	LS5070	70mm
LS5032	32mm	LS5075	75mm
LS5034	34mm	LS5080	80mm
LS5036	36mm	LS5085	85mm
LS5038	38mm	LS5090	90mm
LS5040	40mm		

● T25 Torx

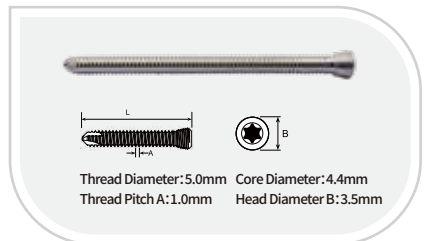
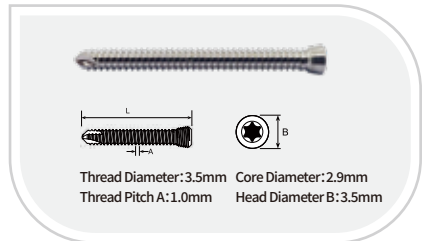
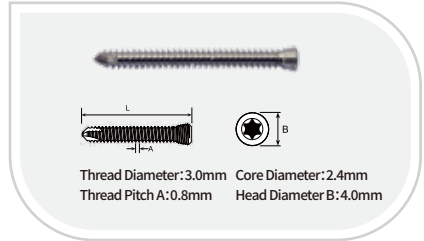

Titanium Cortex Screw

ø1.1mm Cortex Screw Self-tapping		Veterinary Use Only	Titanium Grade 5
Code	L	Code	L
TCS1104	4mm	TCS1108	8mm
TCS1105	5mm	TCS1109	9mm
TCS1106	6mm	TCS1110	10mm
TCS1107	7mm	TCS1112	12mm

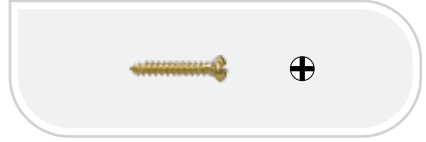

● 1.5 Cruciform Matching with ALPS 3.5/4.2

ø1.5mm Cortex Screw Self-tapping		Veterinary Use Only	Titanium Grade 5
Code	L	Code	L
TCS1506	6mm	TCS1518	18mm
TCS1507	7mm	TCS1520	20mm
TCS1508	8mm	TCS1522	22mm
TCS1509	9mm	TCS1524	24mm
TCS1510	10mm	TCS1526	26mm
TCS1512	12mm	TCS1528	28mm
TCS1514	14mm	TCS1530	30mm
TCS1516	16mm		



● T6 Torx Matching with ALPS 5/6.5 and TTA System

ø2.0mm Cortex Screw Self-tapping		Veterinary Use Only	Titanium Grade 5
Code	L	Code	L
TCS2006	6mm	TCS2016	16mm
TCS2007	7mm	TCS2018	18mm
TCS2008	8mm	TCS2020	20mm
TCS2010	10mm	TCS2022	22mm
TCS2012	12mm	TCS2024	24mm
TCS2014	14mm	TCS2026	26mm

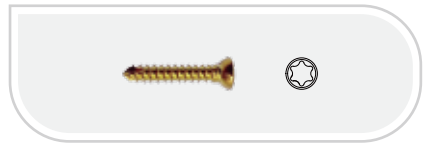

● T6 Torx Matching with ALPS 5/6.5 and TTA System

ø2.4mm Cortex Screw Self-tapping		Veterinary Use Only	Titanium Grade 5
Code	L	Code	L
TCS2408	8mm	TCS2422	22mm
TCS2410	10mm	TCS2424	24mm
TCS2412	12mm	TCS2426	26mm
TCS2414	14mm	TCS2428	28mm
TCS2416	16mm	TCS2430	30mm
TCS2418	18mm	TCS2432	32mm
TCS2420	20mm		

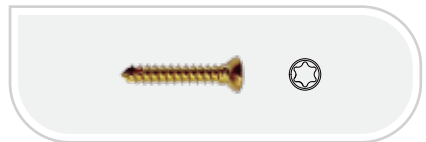

● T10 Torx Matching with ALPS 7.5/8.5 and TTA System

Titanium Cortex Screw

ø2.7mm Cortex Screw Self-tapping		Veterinary Use Only	Titanium Grade 5
Code	L	Code	L
TCS2710	10mm	TCS2724	24mm
TCS2712	12mm	TCS2726	26mm
TCS2714	14mm	TCS2728	28mm
TCS2716	16mm	TCS2730	30mm
TCS2718	18mm	TCS2732	32mm
TCS2720	20mm	TCS2734	34mm
TCS2722	22mm		

- T10 Torx Matching with ALPS 10/11.5 and TTA System

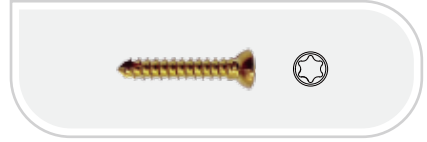

ø3.5mm Cortex Screw Self-tapping		Veterinary Use Only	Titanium Grade 5
Code	L	Code	L
TCS3512	12mm	TCS3532	32mm
TCS3514	14mm	TCS3534	34mm
TCS3516	16mm	TCS3536	36mm
TCS3518	18mm	TCS3538	38mm
TCS3520	20mm	TCS3540	40mm
TCS3522	22mm	TCS3545	45mm
TCS3524	24mm	TCS3550	50mm
TCS3526	26mm	TCS3555	55mm
TCS3528	28mm	TCS3560	60mm
TCS3530	30mm		

- T15 Torx Matching with TTA System



FKS Titanium Locking Screw

ø1.3mm Micro FKS Locking

Veterinary Use Only Titanium Grade 5

Code	L	Code	L
FKS1306	6mm	FKS1310	10mm
FKS1307	7mm	FKS1312	12mm
FKS1308	8mm	FKS1314	14mm
FKS1309	9mm	FKS1316	16mm



● T4 Torx

ø1.7mm Micro FKS Locking

Veterinary Use Only Titanium Grade 5

Code	L	Code	L
FKS1706	6mm	FKS1712	12mm
FKS1707	7mm	FKS1714	14mm
FKS1708	8mm	FKS1716	16mm
FKS1709	9mm	FKS1718	18mm
FKS1710	10mm	FKS1720	20mm

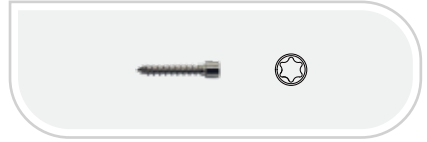

● T4 Torx

ø2.0mm FKS Locking Screw

Veterinary Use Only Titanium Grade 5

Code	L	Code	L
FKS2006	6mm	FKS2012	12mm
FKS2007	7mm	FKS2014	14mm
FKS2008	8mm	FKS2016	16mm
FKS2009	9mm	FKS2018	18mm
FKS2010	10mm		



● T8 Torx

ø2.5mm FKS Locking Screw

Veterinary Use Only Titanium Grade 5

Code	L	Code	L
FKS2510	10mm	FKS2522	22mm
FKS2512	12mm	FKS2524	24mm
FKS2514	14mm	FKS2526	26mm
FKS2516	16mm	FKS2528	28mm
FKS2518	18mm	FKS2530	30mm
FKS2520	20mm		



● T8 Torx

FKS Titanium Locking Screw

ø3.0mm FKS Locking Screw

 Veterinary
Use Only

 Titanium
Grade 5

Code	L	Code	L
FKS3010	10mm	FKS3022	22mm
FKS3012	12mm	FKS3024	24mm
FKS3014	14mm	FKS3026	26mm
FKS3016	16mm	FKS3028	28mm
FKS3018	18mm	FKS3030	30mm
FKS3020	20mm		



● T10 Torx

ø3.5mm FKS Locking Screw

 Veterinary
Use Only

 Titanium
Grade 5

Code	L	Code	L
FKS3512	12mm	FKS3532	32mm
FKS3514	14mm	FKS3534	34mm
FKS3516	16mm	FKS3536	36mm
FKS3518	18mm	FKS3538	38mm
FKS3520	20mm	FKS3542	42mm
FKS3522	22mm	FKS3546	46mm
FKS3524	24mm	FKS3550	50mm
FKS3526	26mm	FKS3554	54mm
FKS3528	28mm	FKS3558	58mm
FKS3530	30mm		



● T10 Torx

Screw Caddy



BIORTHO ALPS Screws Caddy

Code	Specification
ALPS00	225X115X50mm

1.1mm Cortex Screw Selftapping 1.5mm Cruciform

Code	L	Holes
TCS1104	4mm	6
TCS1105	5mm	6
TCS1106	6mm	6
TCS1107	7mm	6
TCS1108	8mm	3
TCS1109	9mm	3
TCS1110	10mm	3
TCS1112	12mm	3

2.4mm Cortex Screw Selftapping T10 Torx

Code	L	Holes
TCS2408	8mm	6
TCS2410	10mm	6
TCS2412	12mm	6
TCS2414	14mm	6
TCS2416	16mm	6
TCS2418	18mm	6
TCS2420	20mm	6
TCS2422	22mm	3
TCS2424	24mm	3
TCS2426	26mm	3
TCS2428	28mm	3
TCS2430	30mm	3
TCS2432	32mm	3

1.6mm Locking Self Tapping Screws 1.5mm Cruciform

Code	L	Holes
B1604	4mm	6
B1605	5mm	6
B1606	6mm	6
B1607	7mm	6
B1608	8mm	3
B1610	10mm	3

2.4mm Locking Self Tapping Screws T6 Torx

Code	L	Holes
B2405	5mm	6
B2406	6mm	6
B2408	8mm	6
B2410	10mm	6
B2412	12mm	6
B2414	14mm	6
B2416	16mm	6
B2418	18mm	3
B2420	20mm	3
B2422	22mm	3
B2424	24mm	3

1.5mm Cortex Screw Selftapping T6 Torx

Code	L	Holes
TCS1506	6mm	6
TCS1507	7mm	6
TCS1508	8mm	6
TCS1510	10mm	6
TCS1512	12mm	6
TCS1514	14mm	6
TCS1516	16mm	6
TCS1518	18mm	6
TCS1520	20mm	3
TCS1522	22mm	3
TCS1524	24mm	3
TCS1526	26mm	3
TCS1528	28mm	3
TCS1530	30mm	3

2.7mm Cortex Screw Selftapping T10 Torx

Code	L	Holes
TCS2710	10mm	3
TCS2712	12mm	3
TCS2714	14mm	6
TCS2716	16mm	6
TCS2718	18mm	6
TCS2720	20mm	6
TCS2722	22mm	6
TCS2724	24mm	6
TCS2726	26mm	6
TCS2728	28mm	3
TCS2730	30mm	3
TCS2732	32mm	3
TCS2734	34mm	3

3.2mm Locking Self Tapping Screws T10 Torx

Code	L	Holes
B3208	8mm	6
B3210	10mm	6
B3212	12mm	6
B3214	14mm	6
B3216	16mm	6
B3218	18mm	6
B3220	20mm	6
B3222	22mm	6
B3224	24mm	3
B3226	26mm	3
B3228	28mm	3
B3230	30mm	3
B3232	32mm	3
B3234	34mm	3

4.0mm Locking Self Tapping Screws T10 Torx

Code	L	Holes
B4010	10mm	3
B4012	12mm	3
B4014	14mm	6
B4016	16mm	6
B4018	18mm	6
B4020	20mm	6
B4022	22mm	6
B4024	24mm	6
B4026	26mm	6
B4028	28mm	6
B4030	30mm	3
B4032	32mm	3
B4034	34mm	3
B4036	36mm	3
B4038	38mm	3
B4040	40mm	3

Screw Caddy



BIORTHO Standard Screw Caddy(1.5/2.0/2.4/2.7/3.5mm)

Code	Specification
CSTT00	225X115X50mm

1.5mm Cortex Screw Selftapping T6 Torx			
Code	L	Holes	
CSTT1505	5mm	8	
CSTT1506	6mm	8	
CSTT1507	7mm	8	
CSTT1508	8mm	8	
CSTT1510	10mm	8	
CSTT1512	12mm	8	
CSTT1514	14mm	3	
CSTT1516	16mm	3	
CSTT1518	18mm	3	
CSTT1520	20mm	3	

2.0mm Cortex Screw Selftapping T6 Torx			
Code	L	Holes	
CSTT2006	6mm	8	
CSTT2007	7mm	8	
CSTT2008	8mm	8	
CSTT2009	9mm	8	
CSTT2010	10mm	8	
CSTT2012	12mm	8	
CSTT2014	14mm	8	
CSTT2016	16mm	8	
CSTT2018	18mm	8	
CSTT2020	20mm	3	
CSTT2022	22mm	3	
CSTT2024	24mm	3	
CSTT2026	26mm	3	

2.4mm Cortex Screw Selftapping T8 Torx			
Code	L	Holes	
CSTT2408	8mm	8	
CSTT2410	10mm	8	
CSTT2412	12mm	8	
CSTT2414	14mm	8	
CSTT2416	16mm	8	
CSTT2418	18mm	8	
CSTT2420	20mm	8	
CSTT2422	22mm	8	
CSTT2424	24mm	3	
CSTT2426	26mm	3	
CSTT2428	28mm	3	
CSTT2430	30mm	3	

2.7mm Cortex Screw Selftapping T8 Torx			
Code	L	Holes	
CSTT2708	8mm	6	
CSTT2710	10mm	6	
CSTT2712	12mm	6	
CSTT2714	14mm	6	
CSTT2716	16mm	6	
CSTT2718	18mm	6	
CSTT2720	20mm	6	
CSTT2722	22mm	6	
CSTT2724	24mm	6	
CSTT2726	26mm	6	
CSTT2728	28mm	3	
CSTT2730	30mm	3	
CSTT2732	32mm	3	
CSTT2734	34mm	3	

3.5mm Cortex Screw Selftapping T15 Torx			
Code	L	Holes	
CSTT3512	12mm	6	
CSTT3514	14mm	6	
CSTT3516	16mm	6	
CSTT3518	18mm	6	
CSTT3520	20mm	6	
CSTT3522	22mm	6	
CSTT3524	24mm	6	
CSTT3526	26mm	6	
CSTT3528	28mm	6	
CSTT3530	30mm	6	
CSTT3532	32mm	6	
CSTT3534	34mm	3	
CSTT3536	36mm	3	
CSTT3538	38mm	3	
CSTT3540	40mm	3	

Screw Caddy



Screw Caddy 1.5/2.0/2.4mm

Code	Specification
MINI.014A	150X95X36mm

1.5mm Cortex Self Tapping Screws T6 Torx

Code	L	Holes
CSTT1505	5mm	5
CSTT1506	6mm	5
CSTT1507	7mm	5
CSTT1508	8mm	5
CSTT1509	9mm	5
CSTT1510	10mm	5
CSTT1511	11mm	5
CSTT1512	12mm	5
CSTT1514	14mm	5
CSTT1516	16mm	5
CSTT1518	18mm	5
CSTT1520	20mm	5

2.0mm Cortex Self Tapping Screws T6 Torx

Code	L	Holes
CSTT2006	6mm	6
CSTT2007	7mm	6
CSTT2008	8mm	6
CSTT2009	9mm	6
CSTT2010	10mm	6
CSTT2012	12mm	6
CSTT2014	14mm	6
CSTT2016	16mm	6
CSTT2018	18mm	6
CSTT2020	20mm	6
CSTT2022	22mm	6
CSTT2024	24mm	6

2.4mm Cortex Self Tapping Screws T8 Torx

Code	L	Holes
CSTT2408	8mm	6
CSTT2410	10mm	6
CSTT2412	12mm	6
CSTT2414	14mm	6
CSTT2416	16mm	6
CSTT2418	18mm	6
CSTT2420	20mm	6
CSTT2422	22mm	6
CSTT2424	24mm	6
CSTT2426	26mm	6
CSTT2428	28mm	6

Screw Caddy



Locking Screws Caddy 1.5/2.0/2.4mm

Code	Specification
025.009	180X100X40mm

1.5mm Locking Self Tapping Screws T4 Torx

Code	L	Holes
LS1505	5mm	5
LS1506	6mm	5
LS1507	7mm	5
LS1508	8mm	5
LS1509	9mm	5
LS1510	10mm	5
LS1511	11mm	5
LS1512	12mm	5
LS1513	13mm	5
LS1514	14mm	5
LS1516	16mm	5
LS1518	18mm	2
LS1520	20mm	2
LS1522	22mm	2
LS1524	24mm	2

1.5mm Cortex Self Tapping Screws T4 Torx

Code	L	Holes
VS105.05	5mm	3
VS105.06	6mm	3
VS105.07	7mm	3
VS105.08	8mm	3
VS105.09	9mm	3
VS105.10	10mm	3
VS105.11	11mm	3
VS105.12	12mm	3
VS105.13	13mm	3
VS105.14	14mm	3
VS105.16	16mm	3
VS105.18	18mm	2
VS105.20	20mm	2
VS105.22	22mm	1
VS105.24	24mm	1

2.4mm Locking Self Tapping Screws T8 Torx

Code	L	Holes
LS2406	6mm	5
LS2408	8mm	5
LS2410	10mm	5
LS2411	11mm	5
LS2412	12mm	5
LS2413	13mm	5
LS2414	14mm	5
LS2416	16mm	5
LS2418	18mm	5
LS2420	20mm	5
LS2422	22mm	5
LS2424	24mm	5
LS2426	26mm	2
LS2428	28mm	2
LS2430	30mm	2
LS2432	32mm	2
LS2434	34mm	2
LS2436	36mm	2
LS2438	38mm	2
LS2440	40mm	2

2.4mm Cortex Self Tapping Screws T8 Torx

Code	L	Holes
CSTT2406	6mm	3
CSTT2408	8mm	3
CSTT2410	10mm	3
CSTT2411	11mm	3
CSTT2412	12mm	3
CSTT2413	13mm	3
CSTT2414	14mm	3
CSTT2416	16mm	3
CSTT2418	18mm	3
CSTT2420	20mm	3
CSTT2422	22mm	3
CSTT2424	24mm	3
CSTT2426	26mm	2
CSTT2428	28mm	2
CSTT2430	30mm	2
CSTT2432	32mm	2
CSTT2434	34mm	1
CSTT2436	36mm	1
CSTT2438	38mm	1
CSTT2440	40mm	1

2.0mm Locking Self Tapping Screws T6 Torx

Code	L	Holes
LS2006	6mm	5
LS2007	7mm	5
LS2008	8mm	5
LS2009	9mm	5
LS2010	10mm	5
LS2011	11mm	5
LS2012	12mm	5
LS2013	13mm	5
LS2014	14mm	5
LS2016	16mm	5
LS2018	18mm	5
LS2020	20mm	5
LS2022	22mm	5
LS2024	24mm	2
LS2026	26mm	2
LS2028	28mm	2
LS2030	30mm	2

2.0mm Cortex Self Tapping Screws T6 Torx

Code	L	Holes
CSTT2006	6mm	3
CSTT2007	7mm	3
CSTT2008	8mm	3
CSTT2009	9mm	3
CSTT2010	10mm	3
CSTT2011	11mm	3
CSTT2012	12mm	3
CSTT2013	13mm	3
CSTT2014	14mm	3
CSTT2016	16mm	3
CSTT2018	18mm	3
CSTT2020	20mm	3
CSTT2022	22mm	3
CSTT2024	24mm	2
CSTT2026	26mm	2
CSTT2028	28mm	1
CSTT2030	30mm	1

Screw Caddy



Locking Screws Caddy 2.7/3.0/3.5mm

Code	Specification
025.010	235X125X73mm

2.7mm Locking Self Tapping Screws T8 Torx

Code	L	Holes
LS2708	8mm	2
LS2710	10mm	2
LS2712	12mm	4
LS2714	14mm	4
LS2716	16mm	4
LS2718	18mm	4
LS2720	20mm	4
LS2722	22mm	4
LS2724	24mm	4
LS2726	26mm	4
LS2728	28mm	4
LS2730	30mm	4
LS2732	32mm	4
LS2734	34mm	2
LS2736	36mm	2
LS2738	38mm	2
LS2740	40mm	2

3.0mm Locking Self Tapping Screws T10 Torx

Code	L	Holes
LS3010	10mm	2
LS3012	12mm	2
LS3014	14mm	4
LS3016	16mm	4
LS3018	18mm	4
LS3020	20mm	4
LS3022	22mm	4
LS3024	24mm	4
LS3026	26mm	4
LS3028	28mm	4
LS3030	30mm	4
LS3032	32mm	4
LS3034	34mm	4
LS3036	36mm	4
LS3038	38mm	2
LS3040	40mm	2

2.7mm Cortex Self Tapping Screws T8 Torx

Code	L	Holes
CSTT2708	8mm	2
CSTT2710	10mm	2
CSTT2712	12mm	4
CSTT2714	14mm	4
CSTT2716	16mm	4
CSTT2718	18mm	4
CSTT2720	20mm	4
CSTT2722	22mm	4
CSTT2724	24mm	4
CSTT2726	26mm	4
CSTT2728	28mm	2
CSTT2730	30mm	2
CSTT2732	32mm	2
CSTT2734	34mm	2
CSTT2736	36mm	2
CSTT2738	38mm	2
CSTT2740	40mm	2
CSTT2742	42mm	2
CSTT2744	44mm	2
CSTT2746	46mm	2
CSTT2748	48mm	2
CSTT2750	50mm	2

3.5mm Locking Self Tapping Screws T15 Torx

Code	L	Holes
LS3510	10mm	3
LS3512	12mm	3
LS3514	14mm	6
LS3516	16mm	6
LS3518	18mm	6
LS3520	20mm	6
LS3522	22mm	6
LS3524	24mm	6
LS3526	26mm	6
LS3528	28mm	6
LS3530	30mm	6
LS3532	32mm	6
LS3534	34mm	6
LS3536	36mm	6
LS3538	38mm	6
LS3540	40mm	6
LS3542	42mm	6
LS3544	44mm	3
LS3546	46mm	3
LS3548	48mm	3
LS3550	50mm	3
LS3555	55mm	3
LS3560	60mm	3

3.5mm Cortex Self Tapping Screws T15 Torx

Code	L	Holes
CSTT3510	10mm	2
CSTT3512	12mm	2
CSTT3514	14mm	4
CSTT3516	16mm	4
CSTT3518	18mm	4
CSTT3520	20mm	4
CSTT3522	22mm	4
CSTT3524	24mm	4
CSTT3526	26mm	4
CSTT3528	28mm	4
CSTT3530	30mm	4
CSTT3532	32mm	4
CSTT3534	34mm	4
CSTT3536	36mm	4
CSTT3538	38mm	4
CSTT3540	40mm	2
CSTT3542	42mm	2
CSTT3544	44mm	2
CSTT3546	46mm	2
CSTT3548	48mm	2
CSTT3550	50mm	2
CSTT3555	55mm	2
CSTT3560	60mm	2

Screw Caddy



5.5mm Cortex Self Tapping Screws Set

Code	Specification
000017	360X160X110mm

5.5mm Cortex Self Tapping Screws 3.5mm hexagonal			5.5mm Cortex Self Tapping Screws 3.5mm hexagonal			5.5mm Cortex Self Tapping Screws 3.5mm hexagonal		
Code	L	Holes	Code	L	Holes	Code	L	Holes
CSST5524	24mm	6	CSST5540	40mm	10	CSST5556	56mm	10
CSST5526	26mm	6	CSST5542	42mm	10	CSST5558	58mm	10
CSST5528	28mm	6	CSST5544	44mm	10	CSST5560	60mm	10
CSST5530	30mm	10	CSST5546	46mm	10	CSST5564	64mm	10
CSST5532	32mm	10	CSST5548	48mm	10	CSST5570	70mm	10
CSST5534	34mm	10	CSST5550	50mm	10	CSST5580	80mm	4
CSST5536	36mm	10	CSST5552	52mm	10	CSST5590	90mm	4
CSST5538	38mm	10	CSST5554	54mm	10	CSST55100	100mm	4



5.0mm Locking Screws Set

Code	Specification
000018	360X160X110mm

5.0mm Locking Self Tapping Screws T25 Torx			5.0mm Locking Self Tapping Screws T25 Torx			5.0mm Locking Self Tapping Screws T25 Torx		
Code	L	Holes	Code	L	Holes	Code	L	Holes
LS5014	14mm	8	LS5032	32mm	10	LS5050	50mm	10
LS5016	16mm	8	LS5034	34mm	10	LS5055	55mm	10
LS5018	18mm	8	LS5036	36mm	10	LS5060	60mm	4
LS5020	20mm	8	LS5038	38mm	10	LS5065	65mm	4
LS5022	22mm	8	LS5040	40mm	10	LS5070	70mm	4
LS5024	24mm	8	LS5042	42mm	10	LS5075	75mm	4
LS5026	26mm	8	LS5044	44mm	10	LS5080	80mm	4
LS5028	28mm	10	LS5046	46mm	10	LS5085	85mm	4
LS5030	30mm	8	LS5048	48mm	10	LS5090	90mm	4

Screw Caddy



Locking Screws Rack 1.5/2.0/2.4mm

Code	Specification
MC152024	225X110X50mm

1.5mm Locking Self Tapping Screws T4 Torx

Code	L	Holes
LS1505	5mm	6
LS1506	6mm	6
LS1507	7mm	6
LS1508	8mm	6
LS1509	9mm	6
LS1510	10mm	6
LS1511	11mm	6
LS1512	12mm	6
LS1514	14mm	6
LS1516	16mm	6
LS1518	18mm	6
LS1520	20mm	6
LS1522	22mm	6
LS1524	24mm	6

1.5mm Cortex Self Tapping Screws T4 Torx

Code	L	Holes
VS105.05	5mm	4
VS105.06	6mm	4
VS105.07	7mm	4
VS105.08	8mm	4
VS105.09	9mm	4
VS105.10	10mm	4
VS105.11	11mm	4
VS105.12	12mm	4
VS105.14	14mm	4
VS105.16	16mm	4
VS105.18	18mm	4
VS105.20	20mm	4
VS105.22	22mm	4
VS105.24	24mm	4

2.4mm Locking Self Tapping Screws T8 Torx

Code	L	Holes
LS2406	6mm	6
LS2408	8mm	6
LS2410	10mm	6
LS2411	11mm	6
LS2412	12mm	6
LS2413	13mm	6
LS2414	14mm	6
LS2416	16mm	6
LS2418	18mm	6
LS2420	20mm	6
LS2422	22mm	6
LS2424	24mm	6
LS2426	26mm	6
LS2428	28mm	6
LS2430	30mm	6
LS2432	32mm	6
LS2434	34mm	6
LS2436	36mm	6
LS2438	38mm	6
LS2440	40mm	6

2.4mm Cortex Self Tapping Screws T8 Torx

Code	L	Holes
CSTT2406	6mm	4
CSTT2408	8mm	4
CSTT2410	10mm	4
CSTT2411	11mm	4
CSTT2412	12mm	4
CSTT2413	13mm	4
CSTT2414	14mm	4
CSTT2416	16mm	4
CSTT2418	18mm	4
CSTT2420	20mm	4
CSTT2422	22mm	4
CSTT2424	24mm	4
CSTT2426	26mm	4
CSTT2428	28mm	4
CSTT2430	30mm	4
CSTT2432	32mm	4
CSTT2434	34mm	4
CSTT2436	36mm	4
CSTT2438	38mm	4
CSTT2440	40mm	4

2.0mm Locking Self Tapping Screws T6 Torx

Code	L	Holes
LS2006	6mm	6
LS2007	7mm	6
LS2008	8mm	6
LS2009	9mm	6
LS2010	10mm	6
LS2011	11mm	6
LS2012	12mm	6
LS2014	14mm	6
LS2016	16mm	6
LS2018	18mm	6
LS2020	20mm	6
LS2022	22mm	6
LS2024	24mm	6

2.0mm Cortex Self Tapping Screws T6 Torx

Code	L	Holes
CSTT2006	6mm	4
CSTT2007	7mm	4
CSTT2008	8mm	4
CSTT2009	9mm	4
CSTT2010	10mm	4
CSTT2011	11mm	4
CSTT2012	12mm	4
CSTT2014	14mm	4
CSTT2016	16mm	4
CSTT2018	18mm	4
CSTT2020	20mm	4
CSTT2022	22mm	4
CSTT2024	24mm	4

Screw Caddy



Locking Screws Rack 2.7/3.0/3.5mm

Code	Specification
MC273035	225X120X80mm

2.7mm Locking Self Tapping Screws T8 Torx

Code	L	Holes
LS2708	8mm	2
LS2710	10mm	2
LS2712	12mm	4
LS2714	14mm	8
LS2716	16mm	8
LS2718	18mm	8
LS2720	20mm	4
LS2722	22mm	4
LS2724	24mm	4
LS2726	26mm	4
LS2728	28mm	4
LS2730	30mm	4
LS2732	32mm	4
LS2734	34mm	2
LS2736	36mm	2
LS2738	38mm	2
LS2740	40mm	2

3.0mm Locking Self Tapping Screws T10 Torx

Code	L	Holes
LS3010	10mm	1
LS3012	12mm	1
LS3014	14mm	4
LS3016	16mm	4
LS3018	18mm	4
LS3020	20mm	4
LS3022	22mm	2
LS3024	24mm	2
LS3026	26mm	2
LS3028	28mm	2
LS3030	30mm	2
LS3032	32mm	2
LS3034	34mm	1
LS3036	36mm	1
LS3038	38mm	1
LS3040	40mm	1

2.7mm Cortex Self Tapping Screws T8 Torx

Code	L	Holes
CSTT2708	8mm	1
CSTT2710	10mm	1
CSTT2712	12mm	2
CSTT2714	14mm	4
CSTT2716	16mm	4
CSTT2718	18mm	4
CSTT2720	20mm	4
CSTT2722	22mm	2
CSTT2724	24mm	2
CSTT2726	26mm	2
CSTT2728	28mm	2
CSTT2730	30mm	2
CSTT2732	32mm	2
CSTT2734	34mm	2
CSTT2736	36mm	2
CSTT2738	38mm	2
CSTT2740	40mm	1
CSTT2742	42mm	1
CSTT2744	44mm	1
CSTT2746	46mm	1
CSTT2748	48mm	1
CSTT2750	50mm	1

3.5mm Locking Self Tapping Screws T15 Torx

Code	L	Holes
LS3510	10mm	2
LS3512	12mm	3
LS3514	14mm	5
LS3516	16mm	5
LS3518	18mm	10
LS3520	20mm	10
LS3522	22mm	10
LS3524	24mm	10
LS3526	26mm	5
LS3528	28mm	5
LS3530	30mm	5
LS3532	32mm	5
LS3534	34mm	5
LS3536	36mm	5
LS3538	38mm	5
LS3540	40mm	5
LS3542	42mm	5
LS3544	44mm	5
LS3546	46mm	3
LS3548	48mm	2
LS3550	50mm	2
LS3555	55mm	2
LS3560	60mm	1

3.5mm Cortex Self Tapping Screws T15 Torx

Code	L	Holes
CSTT3510	10mm	3
CSTT3512	12mm	3
CSTT3514	14mm	3
CSTT3516	16mm	3
CSTT3518	18mm	3
CSTT3520	20mm	6
CSTT3522	22mm	9
CSTT3524	24mm	3
CSTT3526	26mm	3
CSTT3528	28mm	3
CSTT3530	30mm	3
CSTT3532	32mm	3
CSTT3534	34mm	3
CSTT3536	36mm	3
CSTT3538	38mm	3
CSTT3540	40mm	3
CSTT3542	42mm	3
CSTT3544	44mm	3
CSTT3546	46mm	2
CSTT3548	48mm	1
CSTT3550	50mm	1
CSTT3555	55mm	1
CSTT3560	60mm	1

Veterinary Bone Plates



2.7mm Locking Screws

10 12 14 16 18 20 22 24 26 28 30

2.7mm Cortex Screws

10 12 14 16 18 20 22 24 26 28 30

3.5mm Locking

10 12 14 16 18 20 22 24 26 28 30 32 34 36 38 40 45 55

3.5mm Cortex Screws

10 12 14 16 18 20 22 24 26 28 30 32 34 36 38 40 45 55

Stainless Cuttable Plates

1.5mm Cuttable Plates						Veterinary Use Only	Stainless Steel 316LVM
Code	Width	Thickness	Holes Distance	Holes	L		
CP153827	3.8mm	1.3mm	5mm	27	150mm		

Matching Screws ● CSTT15

3+5Holes With Space

4+5Holes With Space



1.5mm Double T Head Cuttable Malleable						Veterinary Use Only	Stainless Steel 316LVM
Code	Width	Thickness	Holes Distance	Holes	L		
MPT153830	3.8mm	1.3mm	5mm	30	160mm		

Matching Screws ● CSTT15



2.0mm Cuttable Plates						Veterinary Use Only	Stainless Steel 316LVM
Code	Width	Thickness	Holes Distance	Holes	L		
CP205533	5.5mm	2.0mm	5.5mm	33	215mm		

Matching Screws ● CSTT20, CSTT15

3+5Holes With Space

6+5Holes With Space

4+6Holes With Space



2.4mm Cuttable Plates						Veterinary Use Only	Stainless Steel 316LVM
Code	Width	Thickness	Holes Distance	Holes	L		
CP246523	6.5mm	1.8mm	6mm	23	161mm		

Matching Screws ● CSTT24

3+5Holes With Space

6+5Holes With Space

2+6Holes With Space



Stainless Cuttable Malleable Plates

1.5mm Cuttable Malleable Plates				Veterinary Use Only	Stainless Steel 316LVM
Code	Width	Thickness	Holes Distance	Holes	L
CM154020	4mm	1.3mm	5mm	20	100mm

Matching Screws ● CSTT15



2.0mm Cuttable Malleable Plates				Veterinary Use Only	Stainless Steel 316LVM
Code	Width	Thickness	Holes Distance	Holes	L
CM205020	5.0mm	1.5mm	5mm	20	100mm

Matching Screws ● CSTT20, CSTT15



2.4mm Cuttable Malleable Plates				Veterinary Use Only	Stainless Steel 316LVM
Code	Width	Thickness	Holes Distance	Holes	L
CM246525	6.5mm	2.0mm	6.5mm	25	161mm

Matching Screws ● CSTT24



2.7mm Cuttable Malleable Plates				Veterinary Use Only	Stainless Steel 316LVM
Code	Width	Thickness	Holes Distance	Holes	L
CM272020	8mm	2.2mm	8mm	20	160mm

Matching Screws ● CSTT24, CSTT27



Stainless Cuttable Malleable Plates

2.0mm High Strength Double Compression Plate

Veterinary Use Only
Stainless Steel 316LVM

Code	Width	Thickness	Holes	L
DCP20180	5.5mm	1.7mm	28	180mm

Matching Screws ● CSTT20, CSTT15



2.4mm High Strength Double Compression Plate

Veterinary Use Only
Stainless Steel 316LVM

Code	Width	Thickness	Holes Distance	Holes	L
DCP24180	7mm	2.3mm	6mm	23	180mm

Matching Screws ● CSTT24



2.7mm High Strength Double Compression Plate

Veterinary Use Only
Stainless Steel 316LVM

Code	Width	Thickness	Holes Distance	Holes	L
DCP27180	8.5mm	3mm	8mm	23	180mm

Matching Screws ● CSTT27



3.5mm Compression Cuttable Malleable

Veterinary Use Only
Stainless Steel 316LVM

Code	Width	Holes	L
RC3522	11mm	22	260mm

Matching Screws ● CSTT35



Stainless Steel Round Hole Plates

‘T’ Plates				Veterinary Use Only	Stainless Steel 316LVM	
Code	Specification	HeadWide	ShaftWidth	Thickness	Holes	L
TP150304	1.5	8.0mm	3.8mm	1.5mm	Head2/Shaft4	29mm
TP150205	1.5	8.0mm	3.8mm	1.5mm	Head2/Shaft5	32mm
TP200204	2.0	12mm	5.2mm	1.5mm	Head2/Shaft4	37mm
TP200203C	Compression2.0	8.8mm	5.2mm	1.5mm	Head2/Shaft4	28mm
TP200205C	Compression2.0	8.8mm	5.2mm	1.5mm	Head2/Shaft5	42mm
TP200303C	Compression2.0	8.8mm	5.2mm	1.5mm	Head3/Shaft3	35mm
TP200304C	Compression2.0	8.8mm	5.2mm	1.5mm	Head3/Shaft4	49mm
TP200308C	Compression2.0	8.8mm	5.2mm	1.5mm	Head3/Shaft8	70mm
TP240307	2.4	11.5mm	6.5mm	2.0mm	Head3/Shaft7	63mm
TP240208	2.4	14mm	6.5mm	2.0mm	Head2/Shaft8	60mm

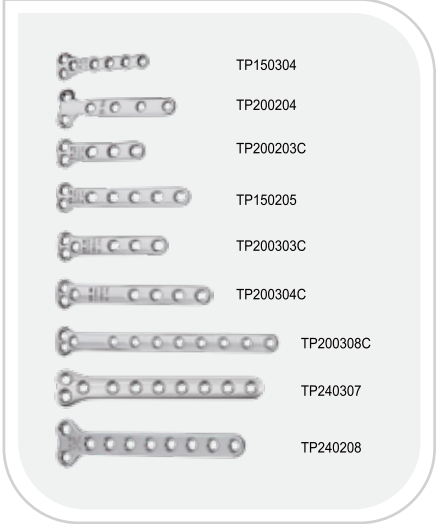

Acetabular Plates

Acetabular Plates		Veterinary Use Only	Stainless Steel 316LVM
Code	Use Screw	Holes	
AP1504	1.5	4	
AP2004	2.0	4	
AP2406	2.4	6	
AP2706	2.7	6	
AP3506	3.5	6	



Butterfly Plate		Veterinary Use Only	Stainless Steel 316LVM
Code	Thickness	Holes	L
BTFP15414	1.5mm	4	14mm
BTFP15415	1.5mm	4	15mm
BTFP15619	1.5mm	6	19mm
BTFP20416	2.0mm	4	16mm
BTFP20417	2.0mm	4	17mm
BTFP20623	2.0mm	6	23mm
BTFP24418	2.4mm	4	18mm
BTFP24420	2.4mm	4	20mm
BTFP24626	2.4mm	6	26mm
BTFP27421	2.7mm	4	21mm
BTFP27425	2.7mm	4	25mm
BTFP27630	2.7mm	6	30mm

1.5mm 1.0mm Plate Thickness 2.0mm 1.5mm Plate Thickness

	BTFP15414		BTFP20416
	BTFP15415		BTFP20417
	BTFP15619		BTFP20623

Supracondylar Plates

Supracondylar Plates			Veterinary Use Only	Stainless Steel 316LVM
Code	Specification	Shaft Width	Holes	L
SP2016L	2.0mm Left	5.5mm	16	75mm
SP2016R	2.0mm Right	5.5mm	16	75mm
SP2410L	2.4mm Left	6.5mm	10	75mm
SP2410R	2.4mm Right	6.5mm	10	75mm



Partial Carpal Arthrodesis Plate			Veterinary Use Only	Stainless Steel 316LVM
Code	Specification	Head Width	Shaft Width	
PCA1520	1.5/2.0mm	8mm	5mm	

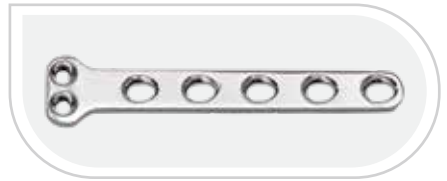

Pantarsal Arthrodesis Plate			Veterinary Use Only	Stainless Steel 316LVM
Code	Specification	Left/Right		
PAP1520R	1.5/2.0mm 120°	Right		
PAP1520L	1.5/2.0mm 120°	Left		
PAP2024R	2.0/2.4mm 120°	Right		
PAP2024L	2.0/2.4mm 120°	Left		

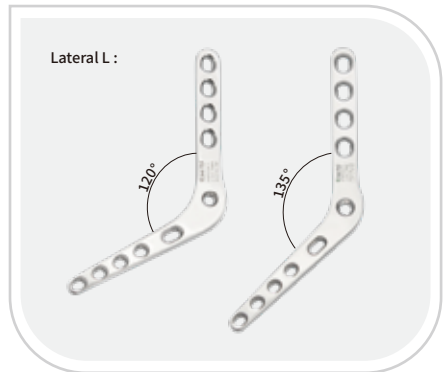

Compression Plates DCP

2.0mm DCP

		Veterinary Use Only		Stainless Steel 316LVM	
Code	Width	Thickness	Holes	L	
200.04	5mm	1.5mm	4	23mm	
200.05	5mm	1.5mm	5	28mm	
200.06	5mm	1.5mm	6	33mm	
200.07	5mm	1.5mm	7	38mm	
200.08	5mm	1.5mm	8	43mm	
200.09	5mm	1.8mm	9	48mm	
200.10	5mm	1.8mm	10	53mm	
200.11	5mm	1.8mm	11	58mm	
200.12	5mm	1.8mm	12	63mm	
200.14	5mm	1.8mm	14	73mm	



Matching Screws ● CSST20

2.7mm DCP

		Veterinary Use Only		Stainless Steel 316LVM	
Code	Width	Thickness	Holes	L	
270.04	8mm	2mm	4	37mm	
270.05	8mm	2mm	5	45mm	
270.06	8mm	2mm	6	53mm	
270.07	8mm	2mm	7	61mm	
270.08	8mm	2mm	8	69mm	
270.09	8mm	2mm	9	77mm	
270.10	8mm	2mm	10	85mm	
270.11	8mm	2mm	11	93mm	
270.12	8mm	2mm	12	101mm	
270.14	8mm	2mm	14	117mm	



Matching Screws ● CSST27

3.5mm DCP-Narrow

		Veterinary Use Only		Stainless Steel 316LVM	
Code	Width	Thickness	Holes	L	
35N.06	10mm	2.8mm	6	77mm	
35N.07	10mm	2.8mm	7	89mm	
35N.08	10mm	2.8mm	8	101mm	
35N.09	10mm	2.8mm	9	113mm	
35N.10	10mm	2.8mm	10	125mm	
35N.12	10mm	2.8mm	12	149mm	
35N.14	10mm	2.8mm	14	173mm	



Matching Screws ● CSST35

3.5mm DCP-Broad

		Veterinary Use Only		Stainless Steel 316LVM	
Code	Width	Thickness	Holes	L	
35B.08	12mm	3.3mm	8	116mm	
35B.10	12mm	3.3mm	10	144mm	
35B.12	12mm	3.3mm	12	172mm	
35B.14	12mm	3.3mm	14	200mm	



Matching Screws ● CSST35

Limited Contact Compression Plates LC-DCP

2.0mm/1.5mm LC-DCP				Veterinary Use Only	Stainless Steel 316LVM
Code	Width	Thickness	Holes Distance	Holes	L
3011.05	5mm	1.8mm	6mm	5	31mm
3011.06	5mm	1.8mm	6mm	6	37mm
3011.07	5mm	1.8mm	6mm	7	43mm
3011.08	5mm	1.8mm	6mm	8	49mm
3011.09	5mm	1.8mm	6mm	9	55mm
3011.10	5mm	1.8mm	6mm	10	61mm
3011.12	5mm	1.8mm	6mm	12	73mm
3011.14	5mm	1.8mm	6mm	14	85mm

Matching Screws ● CSTT20

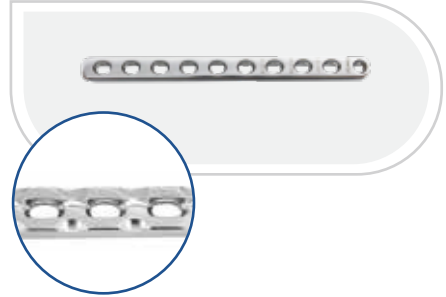

2.4mm/2.0mm LC-DCP				Veterinary Use Only	Stainless Steel 316LVM
Code	Width	Thickness	Holes Distance	Holes	L
3021.04	6.5mm	2.5mm	8mm	4	41mm
3021.05	6.5mm	2.5mm	8mm	5	45mm
3021.06	6.5mm	2.5mm	8mm	6	49mm
3021.07	6.5mm	2.5mm	8mm	7	57mm
3021.08	6.5mm	2.5mm	8mm	8	65mm
3021.09	6.5mm	2.5mm	8mm	9	73mm
3021.10	6.5mm	2.5mm	8mm	10	81mm
3021.12	6.5mm	2.5mm	8mm	12	97mm
3021.14	6.5mm	2.5mm	8mm	14	113mm

Matching Screws ● CSTT20, CSTT24



2.7mm LC-DCP				Veterinary Use Only	Stainless Steel 316LVM
Code	Width	Thickness	Holes Distance	Holes	L
3031.04	8mm	2.5mm	9mm	4	46mm
3031.05	8mm	2.5mm	9mm	5	46mm
3031.06	8mm	2.5mm	9mm	6	55mm
3031.07	8mm	2.5mm	9mm	7	64mm
3031.08	8mm	2.5mm	9mm	8	73mm
3032.09	8mm	3mm	9mm	9	82mm
3032.10	8mm	3mm	9mm	10	91mm
3032.11	8mm	3mm	9mm	11	100mm
3032.12	8mm	3mm	9mm	12	109mm
3032.14	8mm	3mm	9mm	14	127mm
3032.16	8mm	3mm	9mm	16	145mm

Matching Screws ● CSTT27



Limited Contact Compression Plates LC-DCP

3.5mm LC-DCP			Veterinary Use Only	Stainless Steel 316LVM	
Code	Width	Thickness	Holes Distance	Holes	L
3041.06	11mm	3.2mm	13mm	6	80mm
3041.07	11mm	3.2mm	13mm	7	93mm
3041.08	11mm	3.2mm	13mm	8	106mm
3041.09	11mm	3.2mm	13mm	9	119mm
3041.10	11mm	3.2mm	13mm	10	132mm
3041.11	11mm	3.2mm	13mm	11	145mm
3041.12	11mm	3.2mm	13mm	12	158mm
3041.14	11mm	3.2mm	13mm	14	184mm
3041.16	11mm	3.2mm	13mm	16	210mm

Matching Screws ● CSTT35

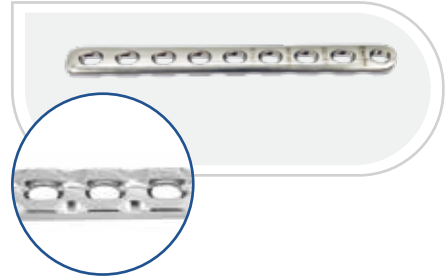

Locking Compression Plates LCP

1.5mm LCP							Veterinary Use Only	Stainless Steel 316LVM
Code	Width	Thickness	HD	CHD	Holes	L		
4011.05	4mm	1.5mm	6mm	4mm	5	30mm		
4011.06	4mm	1.5mm	6mm	4mm	6	36mm		
4011.07	4mm	1.5mm	6mm	4mm	7	42mm		
4011.08	4mm	1.5mm	6mm	4mm	8	48mm		
4011.09	4mm	1.5mm	6mm	4mm	9	54mm		
4011.10	4mm	1.5mm	6mm	4mm	10	60mm		
4011.11	4mm	1.5mm	6mm	4mm	11	66mm		
4011.12	4mm	1.5mm	6mm	4mm	12	72mm		
4011.14	4mm	1.5mm	6mm	4mm	14	84mm		

Matching Screws ● LS15, CSTT15



2.0mm LCP							Veterinary Use Only	Stainless Steel 316LVM
Code	Width	Thickness	HD	CHD	Holes	L		
4012.05	5mm	1.5mm	7mm	5mm	5	34mm		
4012.06	5mm	1.5mm	7mm	5mm	6	41mm		
4012.07	5mm	1.5mm	7mm	5mm	7	48mm		
4012.08	5mm	1.5mm	7mm	5mm	8	55mm		
4012.09	5mm	1.8mm	7mm	5mm	9	62mm		
4012.10	5mm	1.8mm	7mm	5mm	10	69mm		
4012.11	5mm	1.8mm	7mm	5mm	11	76mm		
4012.12	5mm	1.8mm	7mm	5mm	12	83mm		
4012.14	5mm	1.8mm	7mm	5mm	14	97mm		
4012.16	5mm	1.8mm	7mm	5mm	16	111mm		

Matching Screws ● LS20, CSTT20



2.4mm LCP							Veterinary Use Only	Stainless Steel 316LVM
Code	Width	Thickness	HD	CHD	Holes	L		
4021.05	6.5mm	2.2mm	8mm	6mm	5	40mm		
4021.06	6.5mm	2.2mm	8mm	6mm	6	48mm		
4021.07	6.5mm	2.2mm	8mm	6mm	7	56mm		
4021.08	6.5mm	2.2mm	8mm	6mm	8	64mm		
4022.09	6.5mm	2.5mm	8mm	6mm	9	72mm		
4022.10	6.5mm	2.5mm	8mm	6mm	10	80mm		
4022.11	6.5mm	2.5mm	8mm	6mm	11	88mm		
4022.12	6.5mm	2.5mm	8mm	6mm	12	96mm		
4022.14	6.5mm	2.5mm	8mm	6mm	14	112mm		
4022.16	6.5mm	2.5mm	8mm	6mm	16	128mm		

Matching Screws ● LS24, CSTT20, CSTT24



Locking Compression Plates LCP

2.7mm LCP

		Veterinary Use Only		Stainless Steel 316LVM		
Code	Width	Thickness	HD	CHD	Holes	L
4031.05	8mm	2.5mm	9mm	6mm	5	45mm
4031.06	8mm	2.5mm	9mm	6mm	6	54mm
4031.07	8mm	2.5mm	9mm	6mm	7	63mm
4031.08	8mm	2.5mm	9mm	6mm	8	72mm
4031.09	8mm	2.5mm	9mm	6mm	9	81mm
4031.10	8mm	2.5mm	9mm	6mm	10	90mm
4031.11	8mm	2.5mm	9mm	6mm	11	99mm
4031.12	8mm	2.5mm	9mm	6mm	12	108mm
4031.14	8mm	2.5mm	9mm	6mm	14	126mm
4031.16	8mm	2.5mm	9mm	6mm	16	144mm

Matching Screws ● LS27, CSTT27



3.5mm LCP Narrow

		Veterinary Use Only		Stainless Steel 316LVM		
Code	Width	Thickness	HD	CHD	Holes	L
4041.06	11mm	3.2mm	13mm	9.5mm	6	79mm
4041.07	11mm	3.2mm	13mm	9.5mm	7	92mm
4041.08	11mm	3.2mm	13mm	9.5mm	8	105mm
4041.09	11mm	3.2mm	13mm	9.5mm	9	118mm
4041.10	11mm	3.2mm	13mm	9.5mm	10	131mm
4041.11	11mm	3.2mm	13mm	9.5mm	11	144mm
4041.12	11mm	3.2mm	13mm	9.5mm	12	157mm
4041.13	11mm	3.2mm	13mm	9.5mm	13	170mm
4041.14	11mm	3.2mm	13mm	9.5mm	14	183mm
4041.15	11mm	3.2mm	13mm	9.5mm	15	196mm
4041.16	11mm	3.2mm	13mm	9.5mm	16	209mm
4041.18	11mm	3.2mm	13mm	9.5mm	18	235mm

Matching Screws ● LS35, CSTT35, CAN40



3.5mm LCP Broad

		Veterinary Use Only		Stainless Steel 316LVM		
Code	Width	Thickness	HD	CHD	Holes	L
4045.08	13.5mm	4mm	13mm	9.5mm	8	107mm
4045.09	13.5mm	4mm	13mm	9.5mm	9	120mm
4045.10	13.5mm	4mm	13mm	9.5mm	10	133mm
4045.11	13.5mm	4mm	13mm	9.5mm	11	146mm
4045.12	13.5mm	4mm	13mm	9.5mm	12	159mm
4045.13	13.5mm	4mm	13mm	9.5mm	13	172mm
4045.14	13.5mm	4mm	13mm	9.5mm	14	185mm
4045.15	13.5mm	4mm	13mm	9.5mm	15	198mm
4045.16	13.5mm	4mm	13mm	9.5mm	16	211mm
4045.18	13.5mm	4mm	13mm	9.5mm	18	237mm

Matching Screws ● LS35, CSTT35, CAN4.0

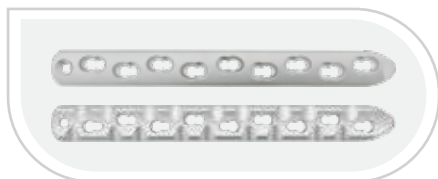

Locking Compression Plates LCP

4.5mm LCP Narrow							Veterinary Use Only	Stainless Steel 316LVM
Code	Width	Thickness	HD	CHD	Holes	L		
4051.03	13.5mm	4.2mm	18mm	12.8mm	3	66mm		
4051.06	13.5mm	4.2mm	18mm	12.8mm	6	107mm		
4051.07	13.5mm	4.2mm	18mm	12.8mm	7	125mm		
4051.08	13.5mm	4.2mm	18mm	12.8mm	8	143mm		
4051.09	13.5mm	4.2mm	18mm	12.8mm	9	161mm		
4051.10	13.5mm	4.2mm	18mm	12.8mm	10	179mm		
4051.11	13.5mm	4.2mm	18mm	12.8mm	11	197mm		
4051.12	13.5mm	4.2mm	18mm	12.8mm	12	215mm		
4051.14	13.5mm	4.2mm	18mm	12.8mm	14	251mm		
4051.16	13.5mm	4.2mm	18mm	12.8mm	16	287mm		

Matching Screws ● LS50, CSST45/CSST45, CAN6.5

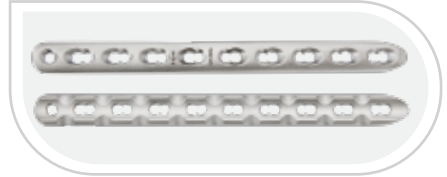

4.5mm LCP Broad							Veterinary Use Only	Stainless Steel 316LVM
Code	Width	Thickness	HD	CHD	Holes	L		
4061.08	17.5mm	5.2mm	18mm	12.8mm	8	143mm		
4061.09	17.5mm	5.2mm	18mm	12.8mm	9	161mm		
4061.10	17.5mm	5.2mm	18mm	12.8mm	10	179mm		
4061.11	17.5mm	5.2mm	18mm	12.8mm	11	197mm		
4061.12	17.5mm	5.2mm	18mm	12.8mm	12	215mm		
4061.13	17.5mm	5.2mm	18mm	12.8mm	13	233mm		
4061.14	17.5mm	5.2mm	18mm	12.8mm	14	251mm		
4061.15	17.5mm	5.2mm	18mm	12.8mm	15	269mm		
4061.16	17.5mm	5.2mm	18mm	12.8mm	16	287mm		
4061.18	17.5mm	5.2mm	18mm	12.8mm	18	323mm		

Matching Screws ● LS50, CSST45/CSST4.5, CAN65



5.5mm LCP Broad							Veterinary Use Only	Stainless Steel 316LVM
Code	Width	Thickness	HD	CHD	Holes	L		
4071.10	17.5mm	6mm	18mm	12.8mm	10	180mm		
4071.11	17.5mm	6mm	18mm	12.8mm	11	198mm		
4071.12	17.5mm	6mm	18mm	12.8mm	12	216mm		
4071.13	17.5mm	6mm	18mm	12.8mm	13	234mm		
4071.14	17.5mm	6mm	18mm	12.8mm	14	252mm		
4071.15	17.5mm	6mm	18mm	12.8mm	15	270mm		
4071.16	17.5mm	6mm	18mm	12.8mm	16	288mm		
4071.17	17.5mm	6mm	18mm	12.8mm	17	306mm		
4071.18	17.5mm	6mm	18mm	12.8mm	18	324mm		

Matching Screws ● LS50, CSST45/CSST45, CSST55/CSST55, CAN65



Locking Compression Plates LCP

Pancarpal Arthrodesis Locking Plate			Veterinary Use Only	Stainless Steel 316LVM
Code	Specification	Holes	L	
4301.10	1.5/2.0mm	12	69mm	
4301.11	2.0/2.4mm	10	88mm	
4301.13	2.0/2.7mm	12	110mm	
4301.12	2.7/3.5mm	12	151mm	

- Matching Screws ● 4301.10 Use LS15/LS20, CSTT15/CSTT20
 ● 4301.11 Use LS20/LS24, CSTT20/CSTT24
 ● 4301.13 Use LS20/LS27, CSTT20/CSTT27
 ● 4301.12 Use LS27/LS35, CSTT27/CSTT35

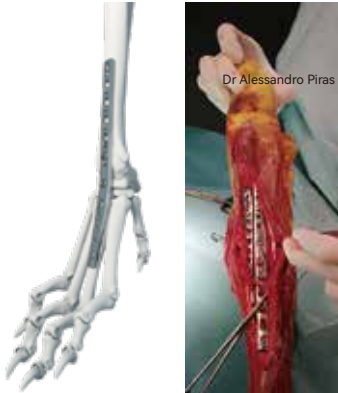

Pantarsal Arthrodesis Locking Plate			Veterinary Use Only	Stainless Steel 316LVM
Code	Specification	Left/Right		
4501.L	1.5/2.0mm 120°	Left		
4501.R	1.5/2.0mm 120°	Right		
4502.L	2.0/2.4mm 120°	Left		
4502.R	2.0/2.4mm 120°	Right		
4507.L	1.5/2.4mm 135°	Left		
4507.R	1.5/2.4mm 135°	Right		
4503.L	2.0/2.7mm 135°	Left		
4503.R	2.0/2.7mm 135°	Right		
4504.L	2.4/3.0mm 135°	Left		
4504.R	2.4/3.0mm 135°	Right		
4505.L	2.4/3.5mm 135°	Left		
4505.R	2.4/3.5mm 135°	Right		
4506.L	2.7/3.5mm 135°	Left		
4506.R	2.7/3.5mm 135°	Right		

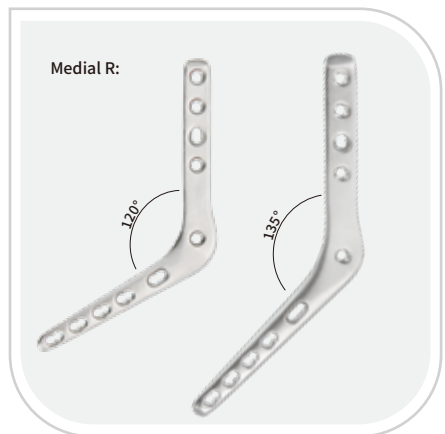

Locking Compression Plates LCP

Dorsal Tarsal Arthrodesis Locking Plate		Veterinary Use Only	Stainless Steel 316LVM
Code	Specification	L	
FP4603	2.7/3.5mm 140°	80+73mm	
FP4602	2.0/2.7mm 140°	56+51mm	

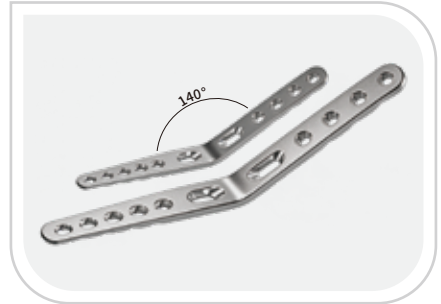

Bio-Glass Injectable Bone Graft Putty

Bio-Glass Injectable Bone Graft Putty		Veterinary Use Only
Code	Specification	
VBG015	1.5ml	

- Comminuted fracture gaps
- TTA / TPLO
- Void filling / Osteotomy sites
- Putty withstands irrigation
- Convenient delivery



Locking Compression Plates LCP

‘T’ Locking Plates		Veterinary Use Only		Stainless Steel 316LVM		
Code	Specification	HW	SW	Thickness	Holes	L
4002.06	1.5	7.2mm	3.8mm	1.5mm	Head2/Shaft4	33mm
4002.08	1.5	7.2mm	3.8mm	1.5mm	Head3/Shaft5	42mm
4620.02	2.0	8.0mm	5.0mm	1.8mm	Head2/Shaft4	38mm
4620.03	2.0	8.0mm	5.0mm	1.8mm	Head3/Shaft5	50mm
4624.02	2.4/2.7	10.8mm	6.8mm	2.5mm	Head2/Shaft4	50mm
4624.03	2.4/2.7	10.8mm	6.8mm	2.5mm	Head3/Shaft5	63mm
4630.02	3.0	14.0mm	8.5mm	3.0mm	Head2/Shaft4	59mm
4630.03	3.0	14.0mm	8.5mm	3.0mm	Head3/Shaft5	75mm
4635.02	3.5	18.0mm	10.5mm	3.3mm	Head2/Shaft4	73mm
4635.03	3.5	18.0mm	10.5mm	3.3mm	Head3/Shaft5	96mm

- Matching Screws**
- 4002.06/4002.08 Use LS15, CSTT15
 - 4620.02/4620.03 Use LS20, CSTT20
 - 4624.02/4624.03 Use LS24/LS27, CSTT24/CSTT27
 - 4630.02/4630.03 Use LS30, CSTT27
 - 4635.02/4635.03 Use LS35, CSTT35

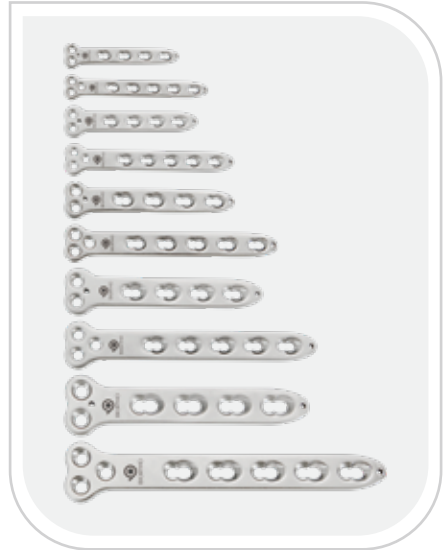
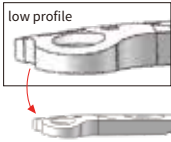

Distal Femoral Polyaxial Locking Plate		Veterinary Use Only		Stainless Steel 316LVM	
Code	Specification	SW	Thickness	Holes	L
4720.L	2.0	5mm	2.0mm	16	85mm
4720.R	2.0	5mm	2.0mm	16	85mm
4724.L	2.4/2.7	7mm	2.5mm	16	105mm
4724.R	2.4/2.7	7mm	2.5mm	16	105mm
4730.L	3.0	9mm	3.0mm	16	135mm
4730.R	3.0	9mm	3.0mm	16	135mm
4735.L	3.5	11mm	3.7mm	16	160mm
4735.R	3.5	11mm	3.7mm	16	160mm

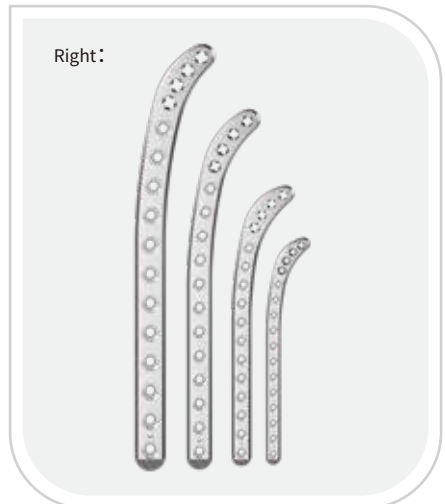

Locking Bridging Plates



Lengthening Locking Plates					Veterinary Use Only	Stainless Steel 316LVM
Code	Width	Thickness	Holes	L		
LLP20540	5mm	1.8mm	5	40mm		
LLP20650	5mm	1.8mm	6	50mm		
LLP20660	5mm	1.8mm	6	60mm		
LLP20670	5mm	1.8mm	6	70mm		
LLP20890	5mm	1.8mm	8	90mm		

Matching Screws ● LS20 The Reconstruction Plate End Can Be Side Contoured Inside 15°

Lengthening Locking Plates					Veterinary Use Only	Stainless Steel 316LVM
Code	Width	Thickness	Holes	L		
LLP24555	6mm	2.3mm	5	55mm		
LLP24670	6mm	2.3mm	6	70mm		
LLP24685	6mm	2.3mm	6	85mm		
LLP247100	6mm	2.3mm	7	100mm		
LLP248120	6mm	2.3mm	8	120mm		

Matching Screws ● LS24 The Reconstruction Plate End Can Be Side Contoured Inside 15°

Lengthening Locking Plates					Veterinary Use Only	Stainless Steel 316LVM
Code	Width	Thickness	Holes	L		
LLP27565	7.5mm	2.6mm	5	65mm		
LLP27680	7.5mm	2.6mm	6	80mm		
LLP276100	7.5mm	2.6mm	6	100mm		
LLP277120	7.5mm	2.6mm	7	120mm		
LLP278140	7.5mm	2.6mm	8	140mm		

Matching Screws ● LS27 The Reconstruction Plate End Can Be Side Contoured Inside 15°

Lengthening Locking Plates					Veterinary Use Only	Stainless Steel 316LVM
Code	Width	Thickness	Holes	L		
LLP30580	9mm	3.2mm	5	80mm		
LLP306100	9mm	3.2mm	6	100mm		
LLP306120	9mm	3.2mm	6	120mm		
LLP307140	9mm	3.2mm	7	140mm		
LLP308160	9mm	3.2mm	8	160mm		

Matching Screws ● LS30 The Reconstruction Plate End Can Be Side Contoured Inside 15°

Lengthening Locking Plates					Veterinary Use Only	Stainless Steel 316LVM
Code	Width	Thickness	Holes	L		
LLP35590	11mm	3.7mm	5	90mm		
LLP356105	11mm	3.7mm	6	105mm		
LLP356120	11mm	3.7mm	6	125mm		
LLP357140	11mm	3.7mm	7	140mm		
LLP358160	11mm	3.7mm	8	160mm		
LLP358200	11mm	3.7mm	8	200mm		

Matching Screws ● LS35 The Reconstruction Plate End Can Be Side Contoured Inside 15°

Cuttable Malleable Locking Plates

Double T Cuttable Locking Plates					Veterinary Use Only	Stainless Steel 316LVM
Code	Width	Thickness	HD	Holes	L	
DTL1532	4.0mm	1.5mm	5.0mm	32	167mm	
DTL2034	5.0mm	1.5mm	5.0mm	34	198mm	
DTL2434	6.5mm	2.0mm	6.5mm	34	235mm	

Matching Screws ● LS15/LS20/LS24



Acetabular Plates			Veterinary Use Only	Stainless Steel 316LVM
Code	Use Screw	Holes		
AP2004L	2.0	4		
AP2406L	2.4	6		
AP2706L	2.7	6		

Matching Screws ● LS20/LS24/LS27



DFO Distal Femur Locking Plate

DFO Distal Femur Locking Plate					Veterinary Use Only	Stainless Steel 316LVM
Code	Width	Thickness	Holes	L		
4408.L3	11mm	3.2mm	7	89mm		
4408.R3	11mm	3.2mm	7	89mm		
4409.L3	11mm	3.2mm	8	101mm		
4409.R3	11mm	3.2mm	8	101mm		

Matching Screws ● LS35 CSTT35



- Anatomic contour matches the surface of the femur.
- Distal locking screw trajectories targeted to avoid the intercondylar notch and stifle joint.
- Tapered design minimizes soft tissue interference.
- Proximal end with reconstruction design for easier contouring

3.5mm DPO/TPO Locking Plates		Veterinary Use Only	Stainless Steel 316LVM
Code	Specification		
4601.L7	20° Left		
4601.R7	20° Right		
4602.L7	25° Left		
4602.R7	25° Right		
4603.L7	30° Left		
4603.R7	30° Right		

Matching Screws ● LS35, CSTT35

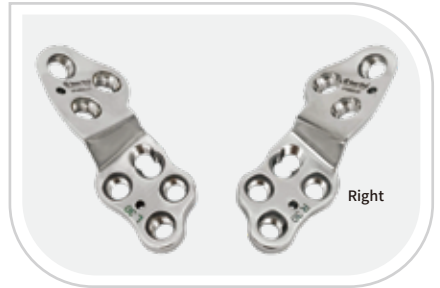

LCP Locking Instrument

Drill Bits

 Veterinary
Use Only

Code	Specification	L
A32A11	1.1mm	85mm
A32A15	1.5mm	125mm
A32A18	1.8mm	150mm
A32A20	2.0mm	150mm
A32A25	2.5mm	150mm
A32A28	2.8mm	150mm
A32A32	3.2mm	150mm
A32A43	4.3mm	280mm



Drill Bits-AO Quick Coupling

 Veterinary
Use Only

Code	Specification	L
A32QC11	1.1mm	60mm
A32QC15	1.5mm	110mm
A32QC18	1.8mm	125mm
A32QC20	2.0mm	125mm
A32QC25	2.5mm	125mm
A32QC28	2.8mm	165mm
A32QC32	3.2mm	150mm
A32QC43	4.3mm	280mm



Star Drive Insert AO QC

 Veterinary
Use Only

Code	Specification	Use Screw
110232	T4	1.5mm Locking Screws
100232	T6	2.0mm Locking Screws
100231	T8	2.4/2.7mm Locking Screws
100230	T15	3.5mm Locking Screws
110230	T25	5.0mm Locking Screws



Hex Screwdriver AO QC

 Veterinary
Use Only

Code	Specification	Use Screw
100226	1.5mm	1.5/2.0/2.4mm Cortex Screws
100228	2.5mm	2.7/3.0/3.5/4.0mm Cortex Screws
100229	3.5mm	4.0/5.5mm Cortex Screws



Ratcheting Screwdriver Handle

 Veterinary
Use Only

Code
120160



LCP Locking Common Instrument

Locking Threaded Drill Guide

Veterinary Use Only

Code	Specification	Use Screw
110189	0.8/1.0mm	AO1.0mm LockingScrews
110188	1.1/1.5mm	AO1.5mm LockingScrews
110187	1.5/2.0mm	AO2.0mm LockingScrews
100186	1.8/2.4mm	AO2.4mm LockingScrews
100185	2.0/2.7mm	AO2.7mm LockingScrews
110180	2.5/3.0mm	AO3.0mm LockingScrews
100184	2.8/3.5mm	AO3.5mm LockingScrews
110183	4.3/5.0mm	AO5.0mm LockingScrews



Torque Limiting Attachment

Veterinary Use Only

Code	Specification
511777	AO QC 0.4Nm
511776	AO QC 0.8Nm
511773	AO QC 1.5Nm



Thread Bender

Veterinary Use Only

Code	Specification
114003	1.5mm
329921	2.0mm
329922	2.4/2.7mm
324023	3.5mm

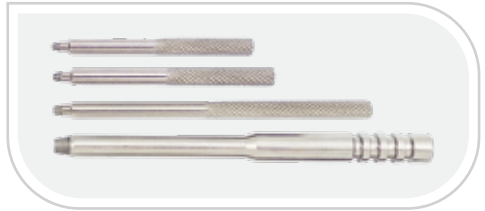

Push-Pull Reduction Device

Veterinary Use Only

Code	Specification
5006	3.5mm
6006	5.0mm

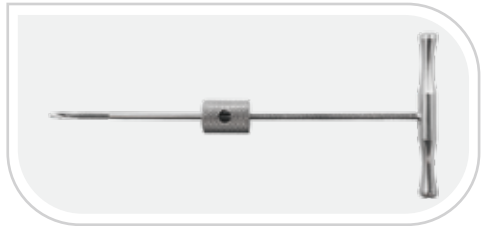

LCP Instrument Set



1.5/2.0/2.4mm Lock Instruments Set

Code	Products Name	Quantity
000018	1.5/2.0/2.4mm Lock Instruments Set	
110188	1.5mm Locking Threaded Drill Guide	2
110187	2.0mm Locking Threaded Drill Guide	2
100186	2.4mm Locking Threaded Drill Guide	2
PRW125	Small Temporary Plate Holding Pins	2
A32QC11	1.1mm AO Quick Fit Drill Bits	1
A32QC15	1.5mm AO Quick Fit Drill Bits	1
A32QC18	1.8mm AO Quick Fit Drill Bits	1
A32QC20	2.0mm AO Quick Fit Drill Bits	1
110232	T4 Star Drive Insert AO QC	1
100232	T6 Star Drive Insert AO QC	1
100231	T8 Star Drive Insert AO QC	1
100226	Screwdriver AO QC	1
100217	Screwholding Sleeve For 1.5/2.0/2.4mm Screws	1
100239b	Φ3mm Countersink AO Quick Fit Coupling	1
100240	Φ4mm Countersink AO Quick Fit Coupling	1
100170	AO Quick Coupling Taps	1
100171	AO Quick Coupling Taps	1
100172	AO Quick Coupling Taps	1
329921	2.0mm Thread Bender	2
329922	2.4/2.7mm Thread Bender	2
100178	1.1/1.5mm Combination Drill	1
100179	1.5/2.0mm Combination Drill	1
100180	1.8/2.4mm Combination Drill	1
100188	1.5/2.0mm Universal Drill Guide	1
100189	1.8/2.4mm Universal Drill Guide	1
100236	Depth gauge 0-30mm	1
100159	AO T Tap Handle	1
110160	AO QC Handle	1
511777	0.4Nm Torque Limiting Aachment	1
511776	0.8Nm Torque Limiting Aachment	1
100234	Screw Holding Forceps	1
18.02	Mini LCP Instrument Sterilization Case	1

2.7/3.5mm Lock Instruments Set

Code	Products Name	Quantity
000019	2.7/3.5mm Lock Instruments Set	
100185	2.7mm Locking Threaded Drill Guide	2
100184	3.5mm Locking Threaded Drill Guide	2
PRW150	Large Temporary Plate Holding Pins	2
A32QC20	2.0mm AO Quick Fit Drill Bits	1
A32QC25	2.5mm AO Quick Fit Drill Bits	1
A32QC28	2.8mm AO Quick Fit Drill Bits	1
A32QC35	3.5mm AO Quick Fit Drill Bits	1
100231	T8 StarDrive Screwdriver shaft	1
100230	T15 StarDrive Screwdriver shaft	1
100228	2.5mm Hex Screwdriver AO QC	1
100220	Screwholding Sleeve For 2.7/3.0/3.5/4.0mm Screws	1
100242	Countersink AO Quick Fit Coupling	1
100173	AO Quick Coupling Taps	1
100174	AO Quick Coupling Taps	1
324023	3.5mm Thread Bender	2
329922	2.4/2.7mm Thread Bender	2
100181	2.0/2.7mm Combination Drill	1
100192	2.0mm Parallel Drill Guide And Drill Sleeve	1
100182	2.5/3.5mm Combination Drill	1
100190	2.0/2.7mm Universal Drill Guide	1
100191	2.5/3.5mm Universal Drill Guide	1
100237	Depth gauge 0-50mm	1
511773	1.5Nm Torque Limiting Aachment	1
511776	0.8Nm Torque Limiting Aachment	1
100159	AO T Tap Handle	1
110160	AO QC Handle	1
100066	2.7/3.5mm Bending Iron	1
5006	3.5mm Push-Pull Reduction Device	1
100233	Screw Holding Forceps	1
19.02	Small LCP Instrument Sterilization Case	1

LCP Plates Set



LCP Plates Set 2.0/2.4/2.7/3.5mm

Code	Products Name	Quantity
	LCP Plates Set 2.0/2.4/2.7/3.5mm	
4012.06	2.0mm LCP Bone Plates 6 Holes 41mm	1
4012.07	2.0mm LCP Bone Plates 7 Holes 48mm	1
4012.08	2.0mm LCP Bone Plates 8 Holes 55mm	1
4012.09	2.0mm LCP Bone Plates 9 Holes 62mm	1
4012.10	2.0mm LCP Bone Plates 10 Holes 69mm	1
4012.12	2.0mm LCP Bone Plates 12 Holes 83mm	1
4012.14	2.0mm LCP Bone Plates 14 Holes 97mm	1
4021.06	2.4mm LCP Bone Plates 6 Holes 48mm	1
4021.07	2.4mm LCP Bone Plates 7 Holes 56mm	1
4021.08	2.4mm LCP Bone Plates 8 Holes 64mm	1
4022.09	2.4mm LCP Bone Plates 9 Holes 72mm	1
4022.10	2.4mm LCP Bone Plates 10 Holes 80mm	1
4022.12	2.4mm LCP Bone Plates 12 Holes 96mm	1
4022.14	2.4mm LCP Bone Plates 14 Holes 112mm	1
4031.06	2.7mm LCP Bone Plates 6 Holes 54mm	1
4031.07	2.7mm LCP Bone Plates 7 Holes 63mm	1
4031.08	2.7mm LCP Bone Plates 8 Holes 72mm	1
4031.09	2.7mm LCP Bone Plates 9 Holes 81mm	1
4031.10	2.7mm LCP Bone Plates 10 Holes 90mm	1
4031.12	2.7mm LCP Bone Plates 12 Holes 108mm	1
4031.14	2.7mm LCP Bone Plates 14 Holes 126mm	1

LCP Plates Set 2.0/2.4/2.7/3.5mm

Code	Products Name	Quantity
4031.16	2.7mm LCP Bone Plates 16 Holes 144mm	1
4041.06	3.5mm LCP Bone Plates Narrow 6 Holes 79mm	1
4041.07	3.5mm LCP Bone Plates Narrow 7 Holes 92mm	1
4041.08	3.5mm LCP Bone Plates Narrow 8 Holes 105mm	1
4041.09	3.5mm LCP Bone Plates Narrow 9 Holes 118mm	1
4041.10	3.5mm LCP Bone Plates Narrow 10 Holes 131mm	1
4041.11	3.5mm LCP Bone Plates Narrow 11 Holes 144mm	1
4041.12	3.5mm LCP Bone Plates Narrow 12 Holes 157mm	1
4041.14	3.5mm LCP Bone Plates Narrow 14 Holes 183mm	1
4041.16	3.5mm LCP Bone Plates Narrow 16 Holes 209mm	1
4045.08	3.5mm LCP Bone Plates Broad 8 Holes 107mm	1
4045.09	3.5mm LCP Bone Plates Broad 9 Holes 120mm	1
4045.10	3.5mm LCP Bone Plates Broad 10 Holes 133mm	1
4045.11	3.5mm LCP Bone Plates Broad 11 Holes 146mm	1
4045.12	3.5mm LCP Bone Plates Broad 12 Holes 159mm	1
4045.13	3.5mm LCP Bone Plates Broad 13 Holes 172mm	1
4045.14	3.5mm LCP Bone Plates Broad 14 Holes 185mm	1
4045.16	3.5mm LCP Bone Plates Broad 16 Holes 211mm	1
4045.18	3.5mm LCP Bone Plates Broad 18 Holes 237mm	1
21.02	LCP Plates Set Sterilization Case	1

Titanium Mini Plates

1.1mm 'T' Plates

			Veterinary Use Only	Titanium Grade 5
Code	Specification	Thickness	Holes	L
T101016	A	1.0mm	5	16mm
T101020	A	1.0mm	6	20mm
T101024	A	1.0mm	7	24mm
T101018	B	1.0mm	5	18mm
T101022	B	1.0mm	6	22mm
T101026	B	1.0mm	7	26mm
T101021	C	1.0mm	6	21mm
T101027	C	1.0mm	7	27mm

Matching Screws ● TCS11

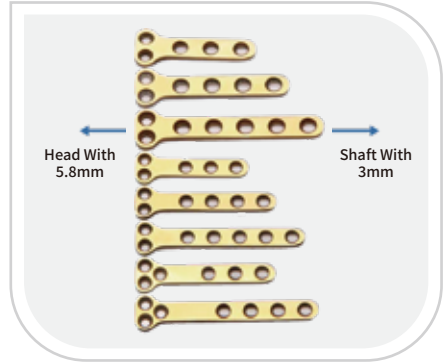
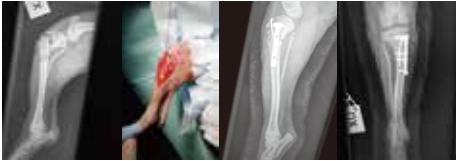

1.1mm Cuttable Plate

			Veterinary Use Only	Titanium Grade 5
Code	Width	Thickness	Holes	L
CP10390	3mm	1mm	30	90mm
CP10391	3mm	1mm	23	91mm
CP1039027	3mm	1mm	27	90mm
CP1039120	3mm	1mm	20	91mm

Matching Screws ● TCS11

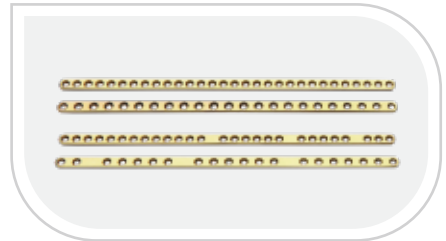

1.1mm Cuttable Malleable Plate

			Veterinary Use Only	Titanium Grade 5
Code	Width	Thickness	Holes	L
CM10390	3mm	1mm	30	90mm

Matching Screws ● TCS11

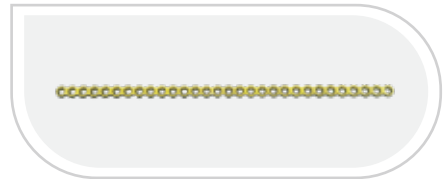

1.1mm Double T Head Cuttable

			Veterinary Use Only	Titanium Grade 5
Code	Width	Thickness	Holes	L
MPT1039030	3mm	1mm	30	90mm

Matching Screws ● TCS11

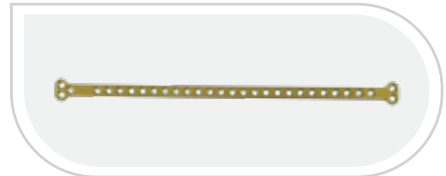

1.1mm Micro Plating System

1.1mm Cruciform Screwdriver

Veterinary Use Only

Code	Products Name
SDIN11	1.1mm Cruciform Screwdriver



1.1mm Micro Plating System

Code	Products Name	Quantity
000010	ALPS-3 Titanium Locking System	
A32A08	Φ0.8 Drill Bit	2
A32A11	Φ1.1 Drill Bit	2
10.02	Φ1.1mm Locking Drill Guide	1
100187	Φ0.8/1.1mm Neutral Drill Guide	1
SDIN11	1.1mm Cruciform Screwdriver	1
T101016	1.1mm 'T' Plates5H 16mm	1
T101020	1.1mm 'T' Plates6H 20mm	1
T101024	1.1mm 'T' Plates7H 24mm	1
T101018	1.1mm 'T' Plates5H 18mm	1
T101022	1.1mm 'T' Plates6H 22mm	1
T101026	1.1mm 'T' Plates7H 26mm	1
T101021	1.1mm 'T' Plates6H 21mm	1
T101027	1.1mm 'T' Plates7H 27mm	1
CP10390	Cutttable Plate 1.1mm 30 Holes 90mm Long	1
CP10391	Cutttable Plate 1.1mm 23 Holes 91mm Long	1
CM10390	Cutttable Malleable Plate 1.1mm 30Holes 90mm Long	1
CP1039027	Cutttable Plate 1.1mm 27 Holes 90mm Long	1

1.1mm Micro Plating System

Code	Products Name	Quantity
ALPS35	Locking Plate 3.5mm Width 1.2mm Thick 30H 135mm Long	1
ALPS42	Locking Plate 4.2mm Width 1.5mm Thick 26H 130mm Long	1
B1604	B1.6X4mm Locking Screw	6-10 PCS
B1605	B1.6X5mm Locking Screw	6-10 PCS
B1606	B1.6X6mm Locking Screw	6-10 PCS
B1607	B1.6X7mm Locking Screw	6-10 PCS
B1608	B1.6X8mm Locking Screw	6-10 PCS
B1610	B1.6X10mm Locking Screw	6-10 PCS
TCS1104	1.1X4mm Cortical Screws Self-Tapping	6-10 PCS
TCS1105	1.1X5mm Cortical Screws Self-Tapping	6-10 PCS
TCS1106	1.1X6mm Cortical Screws Self-Tapping	6-10 PCS
TCS1107	1.1X7mm Cortical Screws Self-Tapping	6-10 PCS
TCS1108	1.1X8mm Cortical Screws Self-Tapping	6-10 PCS
TCS1109	1.1X9mm Cortical Screws Self-Tapping	6-10 PCS
TCS1110	1.1X10mm Cortical Screws Self-Tapping	6-10 PCS
TCS1112	1.1X12mm Cortical Screws Self-Tapping	6-10 PCS
10.01	Caddy	1

TPLO Plate System

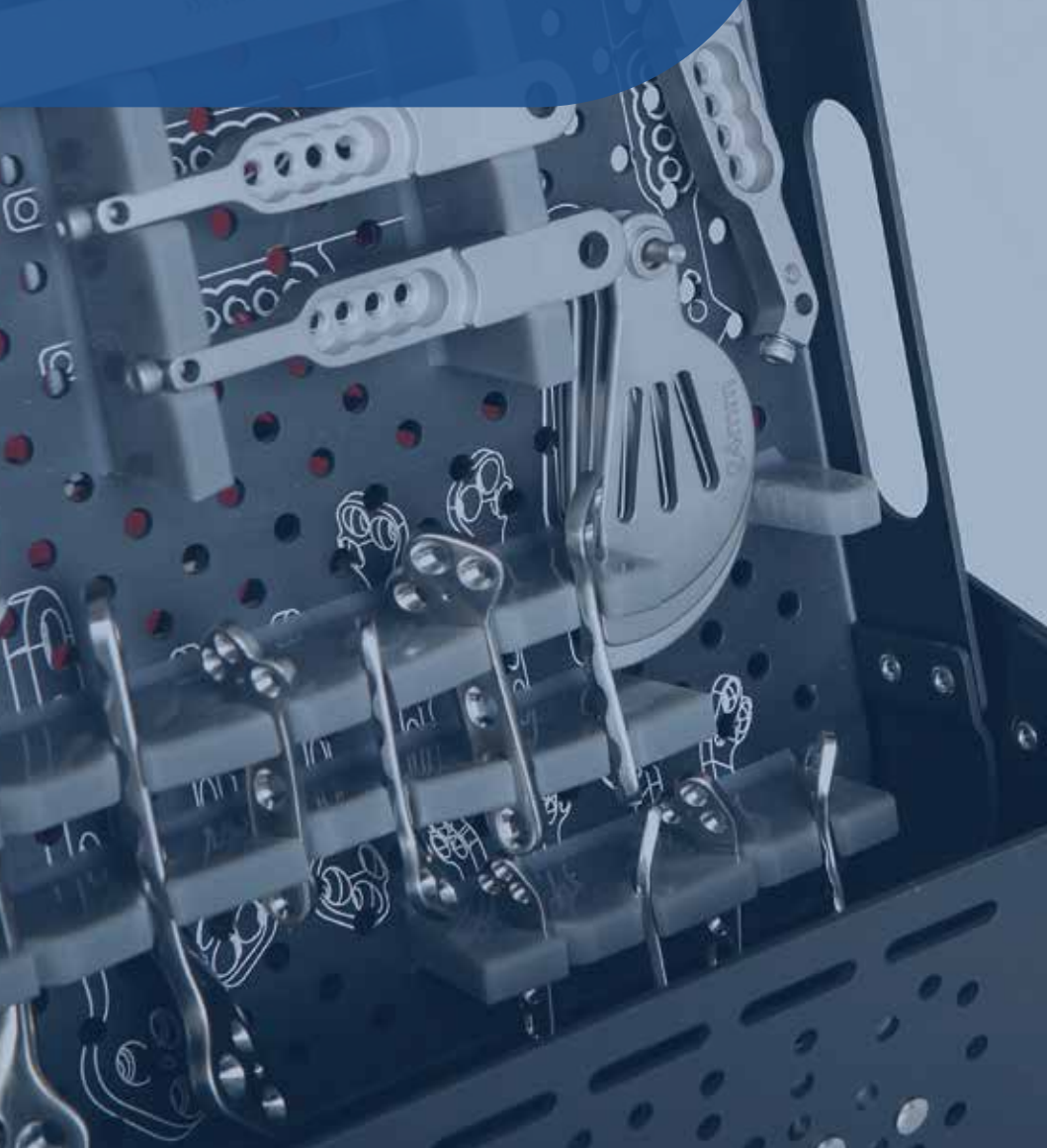

TPLO Plate System

2.0mm TPLO Plates				Veterinary Use Only	Stainless Steel 316LVM
Code	Specification	Holes	Thickness	L	
4405.L3	2.0 Left	Near End 3 Far End 3	2.3mm	30mm	
4405.R3	2.0 Right	Near End 3 Far End 3	2.3mm	30mm	



2.4mm TPLO Plates				Veterinary Use Only	Stainless Steel 316LVM
Code	Specification	Holes	Thickness	L	
4404.L3	2.4 Left	Near End 3 Far End 3	2.3mm	35mm	
4404.R3	2.4 Right	Near End 3 Far End 3	2.3mm	35mm	

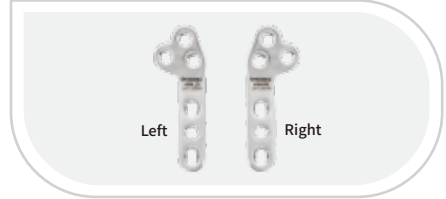

2.7mm TPLO Plates				Veterinary Use Only	Stainless Steel 316LVM
Code	Specification	Holes	Thickness	L	
4400.L3	2.7 Left	Near End 3 Far End 3	2.5mm	46mm	
4400.R3	2.7 Right	Near End 3 Far End 3	2.5mm	46mm	



TPLO Plate System

3.5mm Small TPLO Plate

Veterinary Use Only
Stainless Steel 316LVM

Code	Specification	Holes	Thickness	L
4403.L3	3.5 Left	Near End 3 Far End 3	3.7mm	55mm
4403.R3	3.5 Right	Near End 3 Far End 3	3.7mm	55mm

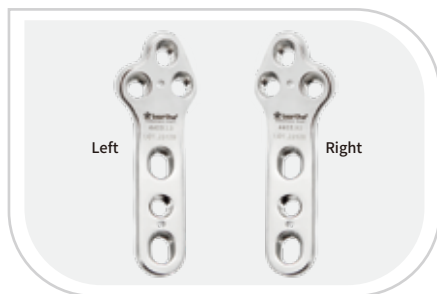

3.5mm TPLO Plate

Veterinary Use Only
Stainless Steel 316LVM

Code	Specification	Holes	Thickness	L
4401.L3	3.5 Left	Near End 3 Far End 3	3.7mm	64mm
4401.R3	3.5 Right	Near End 3 Far End 3	3.7mm	64mm



3.5mm Broad TPLO Plate

Veterinary Use Only
Stainless Steel 316LVM

Code	Specification	Holes	Thickness	L
4402.L4	3.5 Left	Near End 4 Far End 4	3.7mm	80mm
4402.R4	3.5 Right	Near End 4 Far End 4	3.7mm	80mm



TPLO Plate System

5.0mm JUMBO TPLO Plate		Veterinary Use Only	Stainless Steel 316LVM	
Code	Specification	Holes	Thickness	L
4407.L4	5.0	Near End 4 Far End 4	4.8mm	110mm
4407.R4	5.0	Near End 4 Far End 4	4.8mm	110mm



Tibial Plateau Reduction Threaded Pin			Veterinary Use Only
Code	Shaft/Thread Dia	Thread L	L
B1003.15	1.5mm	45mm	150mm
B1203.15	2.0mm	65mm	200mm



TPLO Surgery Instruments

Standard TPLO Jig

Veterinary
Use Only

Code	Products Name	Specification
B0001.00	TPLO JIG	Standard

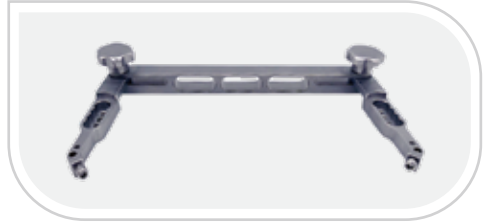

Standard TPLO Jig

Veterinary
Use Only

Code	Products Name	Specification
B0001.01	TPLO Jig Straight Legs	Standard



Standard TPLO Jig

Veterinary
Use Only

Code	Products Name	Specification
B0001.24	Saw Guides	24mm
B0001.27	Saw Guides	27mm
B0001.30	Saw Guides	30mm



Standard TPLO Jig

Veterinary
Use Only

Code	Products Name
B0001.02	Replacement Hinge Screw



Standard TPLO Jig

Veterinary
Use Only

Code	Products Name
B0001.03	Replacement Saw Guide Screw



Standard TPLO Jig

Veterinary
Use Only

Code	Products Name
B0001.04	Long Replacement Jig Pin Screw



TPLO Surgery Instruments

Mini TPLO Jig

Veterinary Use Only

Code	Products Name	Specification
B0002.00	TPLO Jig	Mini



Mini TPLO JIG

Veterinary Use Only

Code	Products Name	Specification
B0002.01	TPLO Jig Straight Legs	Mini



Slocum TPLO JIG

Veterinary Use Only

Code	Products Name	Specification
100323	Slocum TPLO JIG	Small
100322	Slocum TPLO JIG	Large



TPLO Rotary Measuring Device

Veterinary Use Only

Code	Specification	Range
M0013	Small	0-20mm
M0035	Large	0-40mm



TPLO Reduction Forceps

Veterinary Use Only

Code	L	Range
100331	215mm	0-100mm



TPLO SAW

TPLO Saw	Veterinary Use Only
Code	
001.204	



TPLO Battery	Veterinary Use Only
Code	
532.104	



TPLO Battery Charger	Veterinary Use Only
Code	
532.010	



TPLO Saw Sterilization Box	Veterinary Use Only
Code	
532.026	



Wrench For Saw Blade Tightening Nut	Veterinary Use Only
Code	
532.027	



Replacement Jig Pin Screw	Veterinary Use Only
Code	
B0002.04	

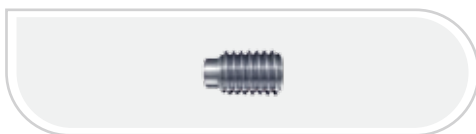

TPLO Related Instruments

TPLO Saw Blades

Veterinary Use Only

Code	Specilaation
000.390	8mm Radius
000.391	10mm Radius
000.392	12mm Radius
000.393	15mm Radius
000.394	18mm Radius
000.395	21mm Radius
000.396	24mm Radius
000.397	27mm Radius

TPLO Saw Blades

Veterinary Use Only

Code	Specilaation
000.389	6mm Radius
000.341	7mm Radius
000.340	9mm Radius
000.398	30mm Radius
000.399	33mm Radius



TPLO Saw Blade Adpater

Veterinary Use Only

Code
100332

- Designed to couple BIORTHO TPLO saw blades to Synthes Colibri Tplo saw.
- To use this adaptor ,requires Star drive T15 or hexagonal 3.0mm (532.027) allen key.



TPLO Set



TPLO Set

Code	Products Name/Specification	Quantity
	TPLO Plates Set	
B0002.00	Mini TPLO Jig	1
B0002.01	Mini TPLO Jig Straight Legs	1
B0001.00	Standard TPLO jig	1
B0001.01	Standard TPLO Jig Straight Legs	1
B0001.24	Saw Guides 24mm	1
B0001.27	Saw Guides 27mm	1
B0001.30	Saw Guides 30mm	1
4405.L3	2.0mm TPLO Plates L	1
4405.R3	2.0mm TPLO Plates R	1
4404.L3	2.4mm TPLO Plates L	1
4404.R3	2.4mm TPLO Plates R	1
4400.L3	2.7mm TPLO Plates L	1
4400.R3	2.7mm TPLO Plates R	1
4401.L3	3.5mm TPLO Plates L	1
4401.R3	3.5mm TPLO Plates R	1
4402.L4	3.5mm Broad TPLO Plates L	1
4402.R4	3.5mm Broad TPLO Plates R	1
4403.L3	3.5mm Small TPLO Plates L	1
4403.R3	3.5mm Small TPLO Plates R	1
20.02	TPLO Sterilization Box	1

3.0mm TPLO Set



3.0mm TPLO Set

Code	Products Name/Specification	Specification
TPLO30	3.0mm TPLO Implants Caddy	235X125X52mm

3.0mm TPLO Set

Code	Products Name	Quantity
A32QC20	2.0mm AO Style Quick Coupling Drill Bits	1
A32QC25	2.5mm AO Style Quick Coupling Drill Bits	1
A32QC27	2.7mm AO Style Quick Coupling Drill Bits	1
100231	T8 Torx Drive Screwdriver shaft	1
1002310	T10 Torx Drive Screwdriver shaft	1
TPLO30L	3.0mm SISU TPLO Plates L	2
TPLO30R	3.0mm SISU TPLO Plates R	2
100181	2.0/2.7mm Double Drill Guide	1
100190	2.0/2.7mm Universal Drill Guide	1
110180	2.5/3.0mm Locking Threaded Drill Guide	2
100336	Three Scales Depth Gauge Range 0-30mm	1
100160	QC Handle 110mm	1
TPLO30	3.0mm TPLO Implants Caddy 235X125X52mm	1
CSTT2708	2.7mm Cortex Self Tapping Screws T8 Torx, L.8mm	3
CSTT2710	2.7mm Cortex Self Tapping Screws T8 Torx, L.10mm	3
CSTT2712	2.7mm Cortex Self Tapping Screws T8 Torx, L.12mm	6
CSTT2714	2.7mm Cortex Self Tapping Screws T8 Torx, L.14mm	6
CSTT2716	2.7mm Cortex Self Tapping Screws T8 Torx, L.16mm	6
CSTT2718	2.7mm Cortex Self Tapping Screws T8 Torx, L.18mm	6
CSTT2720	2.7mm Cortex Self Tapping Screws T8 Torx, L.20mm	6
CSTT2722	2.7mm Cortex Self Tapping Screws T8 Torx, L.22mm	3
CSTT2724	2.7mm Cortex Self Tapping Screws T8 Torx, L.24mm	3
CSTT2726	2.7mm Cortex Self Tapping Screws T8 Torx, L.26mm	3

3.0mm TPLO Set

Code	Products Name	Quantity
CSTT2728	2.7mm Cortex Self Tapping Screws T8 Torx, L.28mm	3
CSTT2730	2.7mm Cortex Self Tapping Screws T8 Torx, L.30mm	3
CSTT2732	2.7mm Cortex Self Tapping Screws T8 Torx, L.32mm	3
CSTT2734	2.7mm Cortex Self Tapping Screws T8 Torx, L.34mm	3
CSTT2736	2.7mm Cortex Self Tapping Screws T8 Torx, L.36mm	3
CSTT2738	2.7mm Cortex Self Tapping Screws T8 Torx, L.38mm	3
CSTT2740	2.7mm Cortex Self Tapping Screws T8 Torx, L.40mm	3
LS3010	3.0mm Locking Self Tapping Screws, T10 Torx, L.10mm	4
LS3012	3.0mm Locking Self Tapping Screws, T10 Torx, L.12mm	4
LS3014	3.0mm Locking Self Tapping Screws, T10 Torx, L.14mm	4
LS3016	3.0mm Locking Self Tapping Screws, T10 Torx, L.16mm	4
LS3018	3.0mm Locking Self Tapping Screws, T10 Torx, L.18mm	4
LS3020	3.0mm Locking Self Tapping Screws, T10 Torx, L.20mm	8
LS3022	3.0mm Locking Self Tapping Screws, T10 Torx, L.22mm	8
LS3024	3.0mm Locking Self Tapping Screws, T10 Torx, L.24mm	8
LS3026	3.0mm Locking Self Tapping Screws, T10 Torx, L.26mm	8
LS3028	3.0mm Locking Self Tapping Screws, T10 Torx, L.28mm	8
LS3030	3.0mm Locking Self Tapping Screws, T10 Torx, L.30mm	8
LS3032	3.0mm Locking Self Tapping Screws, T10 Torx, L.32mm	4
LS3034	3.0mm Locking Self Tapping Screws, T10 Torx, L.34mm	4
LS3036	3.0mm Locking Self Tapping Screws, T10 Torx, L.36mm	4
LS3038	3.0mm Locking Self Tapping Screws, T10 Torx, L.38mm	4
LS3040	3.0mm Locking Self Tapping Screws, T10 Torx, L.40mm	4

5.0mm TPLO Set



5.0mm TPLO Set

Code	Products Name	Quantity
CSST4528	4.5mm Cortex Screws,L.28mm	3
CSST4530	4.5mm Cortex Screws,L.30mm	3
CSST4532	4.5mm Cortex Screws,L.32mm	3
CSST4534	4.5mm Cortex Screws,L.34mm	3
CSST4536	4.5mm Cortex Screws,L.36mm	3
CSST4538	4.5mm Cortex Screws,L.38mm	3
CSST4540	4.5mm Cortex Screws,L.40mm	3
CSST4542	4.5mm Cortex Screws,L.42mm	3
CSST4544	4.5mm Cortex Screws,L.44mm	3
CSST4546	4.5mm Cortex Screws,L.46mm	3
CSST4548	4.5mm Cortex Screws,L.48mm	3
CSST4550	4.5mm Cortex Screws,L.50mm	3
CSST4552	4.5mm Cortex Screws,L.52mm	3
CSST4554	4.5mm Cortex Screws,L.54mm	3
CSST4556	4.5mm Cortex Screws,L.56mm	3
CSST4558	4.5mm Cortex Screws,L.58mm	3
CSST4560	4.5mm Cortex Screws,L.60mm	3
CSST4562	4.5mm Cortex Screws,L.62mm	3
LS5014	5.0mm Locking Self Tapping Screws, T25 Tox,L.14mm	8
LS5016	5.0mm Locking Self Tapping Screws, T25 Tox,L.16mm	8
LS5018	5.0mm Locking Self Tapping Screws, T25 Tox,L.18mm	8
LS5020	5.0mm Locking Self Tapping Screws, T25 Tox,L.20mm	8
LS5022	5.0mm Locking Self Tapping Screws, T25 Tox,L.22mm	8
LS5024	5.0mm Locking Self Tapping Screws, T25 Tox,L.24mm	8
LS5026	5.0mm Locking Self Tapping Screws, T25 Tox,L.26mm	8
LS5028	5.0mm Locking Self Tapping Screws, T25 Tox,L.28mm	8
LS5030	5.0mm Locking Self Tapping Screws, T25 Tox,L.30mm	8
LS5032	5.0mm Locking Self Tapping Screws, T25 Tox,L.32mm	10
LS5034	5.0mm Locking Self Tapping Screws, T25 Tox,L.34mm	10
LS5036	5.0mm Locking Self Tapping Screws, T25 Tox,L.36mm	10
LS5038	5.0mm Locking Self Tapping Screws, T25 Tox,L.38mm	10

5.0mm TPLO Set

Code	Products Name	Quantity
LS5038	5.0mm Locking Self Tapping Screws, T25 Tox,L.38mm	10
LS5042	5.0mm Locking Self Tapping Screws, T25 Tox,L.42mm	10
LS5044	5.0mm Locking Self Tapping Screws, T25 Tox,L.44mm	10
LS5046	5.0mm Locking Self Tapping Screws, T25 Tox,L.46mm	10
LS5048	5.0mm Locking Self Tapping Screws, T25 Tox,L.48mm	10
LS5050	5.0mm Locking Self Tapping Screws, T25 Tox,L.50mm	10
LS5055	5.0mm Locking Self Tapping Screws, T25 Tox,L.55mm	10
LS5060	5.0mm Locking Self Tapping Screws, T25 Tox,L.60mm	4
LS5065	5.0mm Locking Self Tapping Screws, T25 Tox,L.65mm	4
LS5070	5.0mm Locking Self Tapping Screws, T25 Tox,L.70mm	4
LS5075	5.0mm Locking Self Tapping Screws, T25 Tox,L.75mm	4
LS5080	5.0mm Locking Self Tapping Screws, T25 Tox,L.80mm	4
LS5085	5.0mm Locking Self Tapping Screws, T25 Tox,L.85mm	4
LS5090	5.0mm Locking Self Tapping Screws, T25 Tox,L.90mm	4
000018	5.0mm Locking Screws Case	1
200005	Instruments Sterilization Basket.265*120*70mm	1
4407.L4	5.0mm JUMBO TPLO Plate L	3
4407.R4	5.0mm JUMBO TPLO Plate R	3
511.773	Torque Limiting Aachment 4.0NM	1
100239	Depth gauge.90mm For 4.5mm&6.0mm Screws	1
110160	Straight Handle AO QC 160mm	1
100229	Hex Screwdriver AO QC 3.5mm	1
100176	AO Quick Coupling Taps 4.5mm Cancellous Tap	1
110183	Locking Threaded Drill Guide 4.3/5.0mm	2
A32QC32	AO QC Drill Bits 3.2mm	2
110230	Star Drive Insert AO QC T25	1
A32QC43	AO QC Drill Bits 4.3mm	2
100191	Universal Drill Guide 3.2/4.5mm	1
	AO Quick Coupling Taps Locking 5.0mm	1
100159	AO T Tap Handle 75mm	1

TPLO Rotation. Quick Reference Chart.



Rotation Calculation Intended to Leave 5 degrees

TPA Angle	TPLO Blade Size (mm)												
	6	7	8	9	10	12	15	18	21	24	27	30	33
10	0.52	0.61	0.70	0.79	0.87	1.05	1.31	1.57	1.83	2.09	2.36	2.62	2.88
11	0.63	0.73	0.84	0.94	1.05	1.26	1.57	1.88	2.20	2.51	2.83	3.14	3.46
12	0.73	0.86	0.98	1.10	1.22	1.47	1.83	2.20	2.57	2.93	3.30	3.67	4.03
13	0.84	0.98	1.12	1.26	1.40	1.68	2.09	2.51	2.93	3.35	3.77	4.19	4.61
14	0.94	1.10	1.26	1.41	1.57	1.88	2.36	2.83	3.30	3.77	4.24	4.71	5.18
15	1.05	1.22	1.40	1.57	1.75	2.09	2.62	3.14	3.67	4.19	4.71	5.24	5.76
16	1.15	1.34	1.54	1.73	1.92	2.30	2.88	3.46	4.03	4.61	5.18	5.76	6.34
17	1.26	1.47	1.68	1.88	2.09	2.51	3.14	3.77	4.40	5.03	5.65	6.28	6.91
18	1.36	1.59	1.82	2.04	2.27	2.72	3.40	4.08	4.76	5.45	6.13	6.81	7.49
19	1.47	1.71	1.95	2.20	2.44	2.93	3.67	4.40	5.13	5.86	6.60	7.33	8.06
20	1.57	1.83	2.09	2.36	2.62	3.14	3.93	4.71	5.50	6.28	7.07	7.85	8.64
21	1.68	1.95	2.23	2.51	2.79	3.35	4.19	5.03	5.86	6.70	7.54	8.38	9.22
22	1.78	2.08	2.37	2.67	2.97	3.56	4.45	5.34	6.23	7.12	8.01	8.90	9.79
23	1.88	2.20	2.51	2.83	3.14	3.77	4.71	5.65	6.60	7.54	8.48	9.42	10.37
24	1.99	2.32	2.65	2.98	3.32	3.98	4.97	5.97	6.96	7.96	8.95	9.95	10.94
25	2.09	2.44	2.79	3.14	3.49	4.19	5.24	6.28	7.33	8.38	9.42	10.47	11.52
26	2.20	2.57	2.93	3.30	3.67	4.40	5.50	6.60	7.70	8.80	9.90	11.00	12.10
27	2.30	2.69	3.07	3.46	3.84	4.61	5.76	6.91	8.06	9.22	10.37	11.52	12.67
28	2.41	2.81	3.21	3.61	4.01	4.82	6.02	7.23	8.43	9.63	10.84	12.04	13.25
29	2.51	2.93	3.35	3.77	4.19	5.03	6.28	7.54	8.80	10.05	11.31	12.57	13.82
30	2.62	3.05	3.49	3.93	4.36	5.24	6.54	7.85	9.16	10.47	11.78	13.09	14.40
31	2.72	3.18	3.63	4.08	4.54	5.45	6.81	8.17	9.53	10.89	12.25	13.61	14.97
32	2.83	3.30	3.77	4.24	4.71	5.65	7.07	8.48	9.90	11.31	12.72	14.14	15.55
33	2.93	3.42	3.91	4.40	4.89	5.86	7.33	8.80	10.26	11.73	13.19	14.66	16.13
34	3.04	3.54	4.05	4.56	5.06	6.07	7.59	9.11	10.63	12.15	13.67	15.18	16.70
35	3.14	3.67	4.19	4.71	5.24	6.28	7.85	9.42	11.00	12.57	14.14	15.71	17.28
36	3.25	3.79	4.33	4.87	5.41	6.49	8.12	9.74	11.36	12.99	14.61	16.23	17.85
37	3.35	3.91	4.47	5.03	5.59	6.70	8.38	10.05	11.73	13.40	15.08	16.76	18.43
38	3.46	4.03	4.61	5.18	5.76	6.91	8.64	10.37	12.10	13.82	15.55	17.28	19.01
39	3.56	4.15	4.75	5.34	5.93	7.12	8.90	10.68	12.46	14.24	16.02	17.80	19.58
40	3.67	4.28	4.89	5.50	6.11	7.33	9.16	11.00	12.83	14.66	16.49	18.33	20.16
41	3.77	4.40	5.03	5.65	6.28	7.54	9.42	11.31	13.19	15.08	16.96	18.85	20.73
42	3.87	4.52	5.17	5.81	6.46	7.75	9.69	11.62	13.56	15.50	17.44	19.37	21.31
43	3.98	4.64	5.31	5.97	6.63	7.96	9.95	11.94	13.93	15.92	17.91	19.90	21.89
44	4.08	4.76	5.45	6.13	6.81	8.17	10.21	12.25	14.29	16.34	18.38	20.42	22.46
45	4.19	4.89	5.59	6.28	6.98	8.38	10.47	12.57	14.66	16.76	18.85	20.94	23.04

HCS Headless Compression Screw Instruments Set

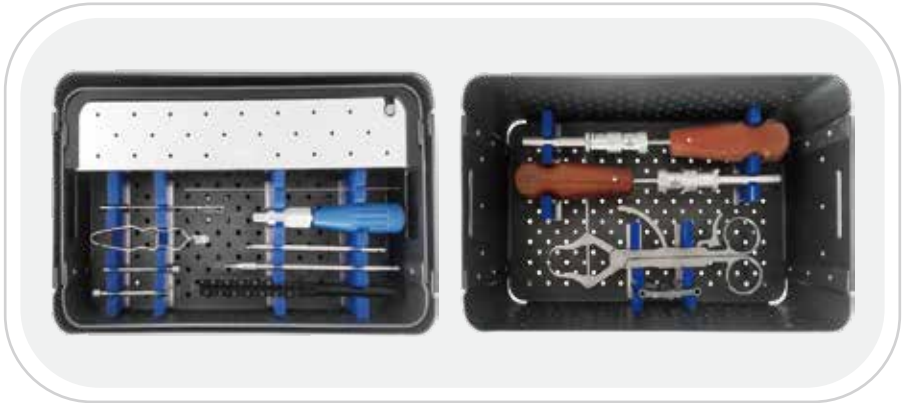

HCS Headless Compression Screw Instruments Set

Code	Products Name/Specification	Quantity
HCS0001	HCS Compression Screw Instruments Set	
301007	Large Aiming Forceps	1
301107	Large Aiming Device	1
301104	Φ1.8mm Drill Sleeve	1
301105	Φ2.0mm Drill Sleeve	1
301108	Φ2.5mm Drill Sleeve	1
HCS0002	2.4/3.0 HCS Compression Screwdriver	1
HCS0003	3.0/4.0 HCS Compression Screwdriver	1
A32CAN20	Φ2.0 Cannulated Screw Jacob QC	1
HCS004	HCS Cannulated Countersink AO QC	1
100160	AO Straight Handle QC	1
HCS005	Cannulated Screw Measuring Device	1
SS4010	1.0mm Guide Wire	2
100227	SW 2.0 Screwdriver Hexagonal AO QC	1
100233	Screw Holding Forceps	1
2.4mm HCS Titanium Compression Screw		
HCS243012	12mm L	4
HCS243014	14mm L	4
HCS243016	16mm L	4
HCS243018	18mm L	4
HCS243020	20mm L	4

HCS Headless Compression Screw Instruments Set

Code	Products Name/Specification	Quantity
HCS243022	22mm L	4
HCS243024	24mm L	4
HCS243026	26mm L	4
HCS243028	28mm L	4
HCS243030	30mm L	4
3.0mm HCS Titanium Compression Screw		
HCS304012	12mm L	4
HCS304014	14mm L	4
HCS304016	16mm L	4
HCS304018	18mm L	4
HCS304020	20mm L	4
HCS304022	22mm L	4
HCS304024	24mm L	4
HCS304026	26mm L	4
HCS304028	28mm L	4
HCS304030	30mm L	4
HCS304032	32mm L	4
HCS304034	34mm L	4
HCS304036	36mm L	4
HCS304038	38mm L	4
HCS304040	40mm L	4

Titanium Headless Compression Screw

2.4/3.0 HCS Titanium Compression Screw	Veterinary Use Only	Titanium Grade 5
Code	L	
HCS243012	12mm	
HCS243014	14mm	
HCS243016	16mm	
HCS243018	18mm	
HCS243020	20mm	
HCS243022	22mm	
HCS243024	24mm	
HCS243026	26mm	
HCS243028	28mm	
HCS243030	30mm	
HCS243032	32mm	
HCS243034	34mm	
HCS243036	36mm	
HCS243038	38mm	
HCS243040	40mm	



3.0/4.0 HCS Titanium Compression Screw	Veterinary Use Only	Titanium Grade 5
Code	L	
HCS304012	12mm	
HCS304014	14mm	
HCS304016	16mm	
HCS304018	18mm	
HCS304020	20mm	
HCS304022	22mm	
HCS304024	24mm	
HCS304026	26mm	
HCS304028	28mm	
HCS304030	30mm	
HCS304032	32mm	
HCS304034	34mm	
HCS304036	36mm	
HCS304038	38mm	
HCS304040	40mm	



Joint And Sports Medicine

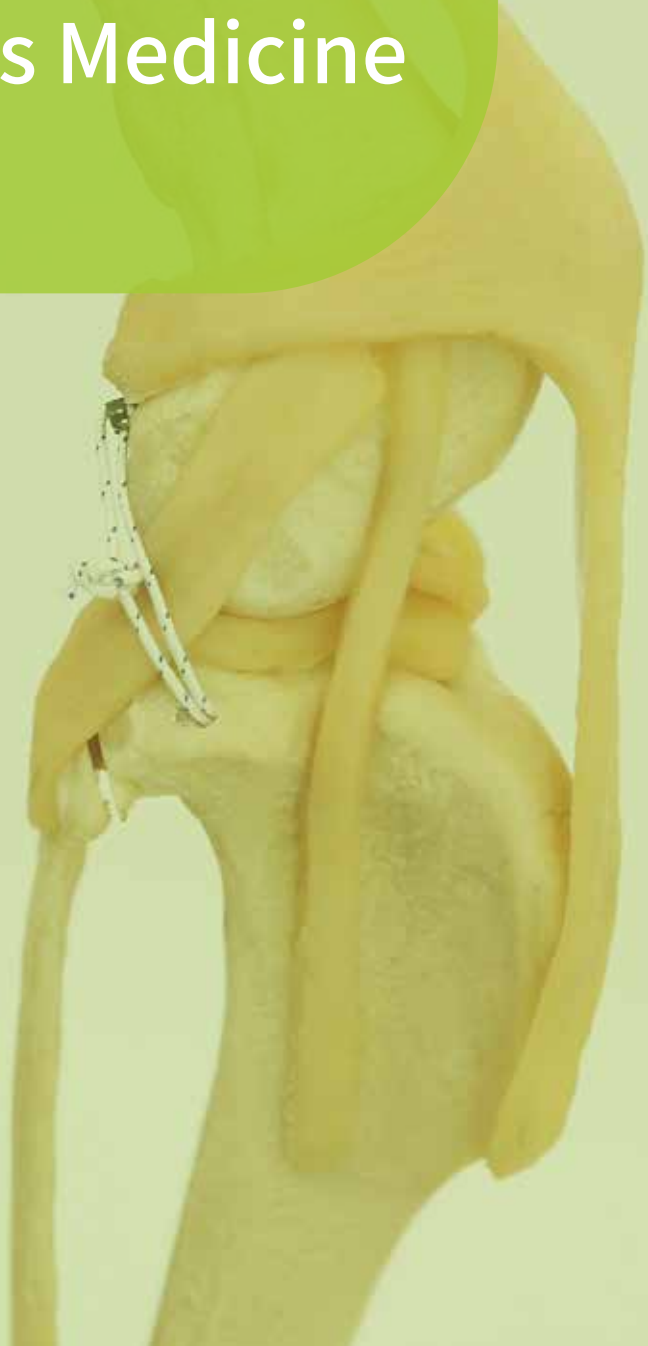

Universal Aim Device



Universal Aim Device Set

Code	Products Name/Specilaiaation	Quantity
Universal Aim Device Set		
UAD0001	Universal Aim Device	1
UAD0015	Drill Sleeve 1.5mm	1
UAD0018	Drill Sleeve 1.8mm	1
UAD0020	Drill Sleeve 2.0mm	1
UAD0025	Drill Sleeve 2.5mm	1
UAD0027	Drill Sleeve 2.7mm	1
UAD0030	Drill Sleeve 3.0mm	1
UAD0035	Drill Sleeve 3.5mm	1
UAD0045	Drill Sleeve 4.5mm	1
SS4015	Guide Pin 1.5mm	2
A32A15	1.5X85mm Drill Bits	1
A32A18	1.8X100mm Drill Bits	1
A32A20	2.0X100mm Drill Bits	1
A32A25	2.5X115mm Drill Bits	1
A32A27	2.7X165mm Drill Bits	1
A32A30	3.0X150mm Drill Bits	1
A32A35	3.5X150mm Drill Bits	1
A32A45	4.5X150mm Drill Bits	1
UAD0003	Universal Aim Device Sterlization Case	1

Coxofemoral Luxation Repair Surgical Procedure

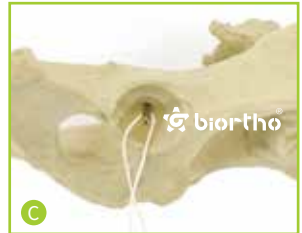
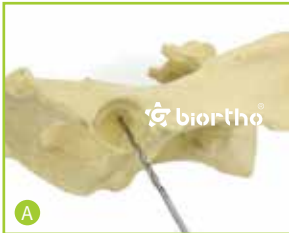

Suture And Anchor System

Gelpi Self Retaining Retractor

Veterinary
Use Only

Code	L
100152	140mm

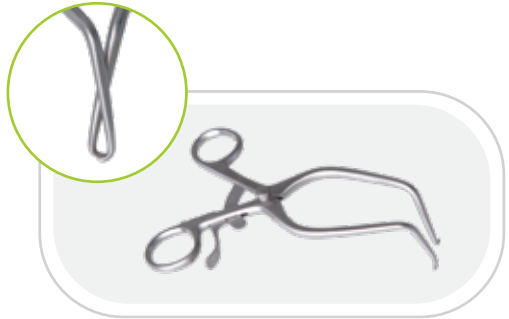

Large Stifle Distractor

Veterinary
Use Only

Code	Specification	L
300001	Large	180mm
300001a	Small	135mm



Crimping Forceps

Veterinary
Use Only

Code
300002



Suture And Anchor System

Nylon Lateral Suture Scissor

Veterinary Use Only

Code	L
300003	145mm



Ligament Tensioning Forceps

Veterinary Use Only

Code	L
300008	170mm



Titanium Button

Veterinary Use Only

Titanium Grade 5

Code	Products Name
TSB20	Two Holes Titanium Button
TSB40	Four Holes Titanium Button



Hip Toggle

Veterinary Use Only

Titanium Grade 5

Code	L	Match with Ultra Sutures
TOG20	Ø2.0*15mm	#2 / #2 Double Loops
TOG25	Ø2.5*20mm	#5 / #5 Double Loops
TOG30	Ø3.0*25mm	#5 Double Loops



Nylon Lateral Suture

Veterinary Use Only

Code	L
AL060	Nylon Lateral Suture 60lb+Crimping 60mm
AL100	Nylon Lateral Suture 100lb+Crimping 60mm



Suture And Anchor System

Ligment Sutures Passer

Veterinary
Use Only

Code	L
300004	1.2X200mm

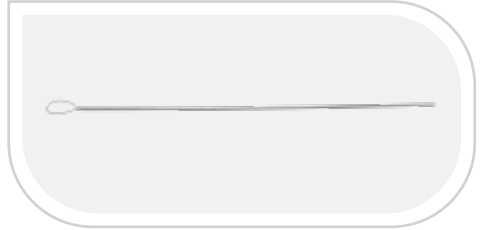

Flexible Ligment Sutures Passer

Veterinary
Use Only

Code	L
300009	0.7X450mm

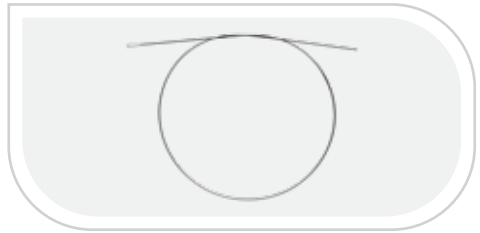

Suture Anchor Pin

Veterinary
Use Only

Titanium
Grade 5

Code	L
SAP25	2.5mm
SAP30	3.0mm
SAP40	4.0mm

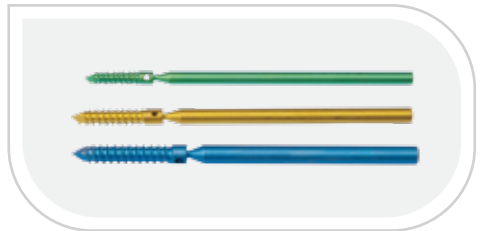

Canine Patellar Block

Veterinary
Use Only

Titanium
Grade 5

Code	L
E070	7mm
E080	8mm
E090	9mm
E100	10mm
E115	11.5mm
E130	13mm



Suture And Anchor System

EasyLock Ultra UHMWPE Sutures

Veterinary Use Only

Code	Products Name	Speciliaation
SAS9520	Ultra PE Suture	#2-0
SAS9502	Ultra PE Suture	#2
SAS9505	Ultra PE Suture	#5

• Sterilized by EO

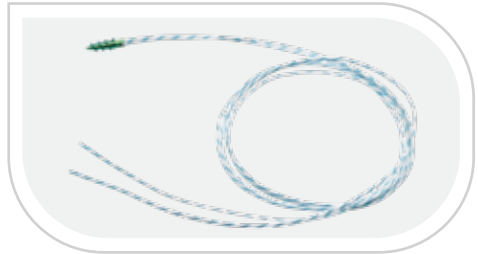

Easy Lock Anchor

Veterinary Use Only

Code	Speciliaation	Matchwith UltraSutures
SAS1805	1.8X5mm	#2-0
SAS1807	1.8X7mm	#2-0
SAS2307	2.3X7mm	#2
SAS2309	2.3X9mm	#2
SAS2808	2.8X8mm	#2
SAS2810	2.8X10mm	#2
SAS3710	3.7X10mm	#5
SAS3712	3.7X12mm	#5
SAS4712	4.7X12mm	#5
SAS4716	4.7X16mm	#5

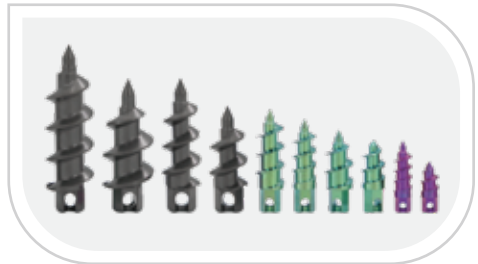

Anchor Driver

Veterinary Use Only

Code	Products Name	Speciliaation
SAS003	Anchor Driver Small	Use 1.8 Anchors
SAS001	Anchor Driver Medium	Use 2.3/2.8 Anchors
SAS002	Anchor Driver Large	Use 3.7/4.7 Anchors



Anchors Rack

Veterinary Use Only

Code	Speciliaation
SAS000	1.8/2.3/2.8/3.7/4.7



Canine Cranial Cruciate Ligament Repair Surgical Procedure



Intramedullary Pin System

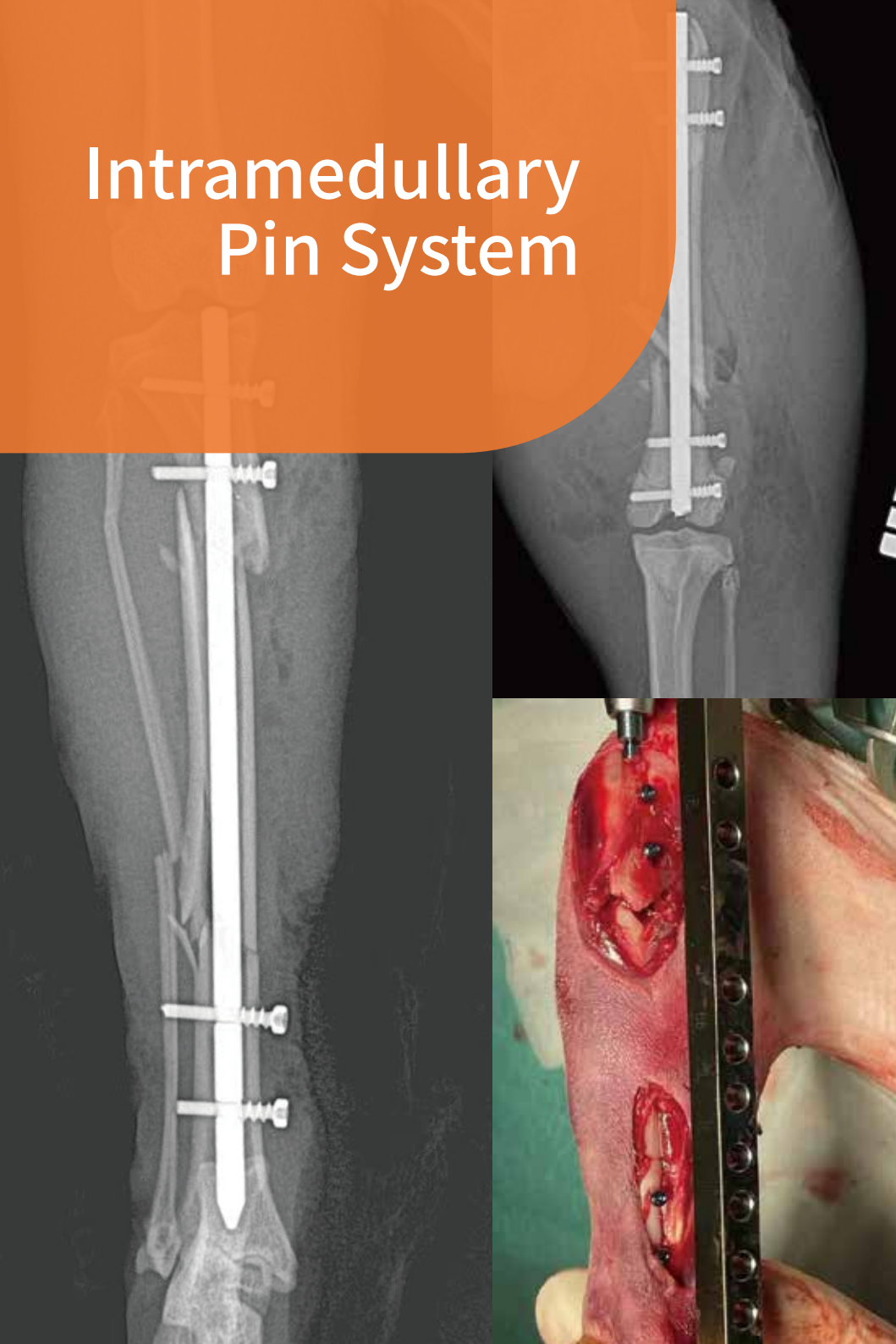

Small Animals Interlocking Nail I-LOCK Set



Small Animals Interlocking Nail I-LOCK Set

Code	Products Name/Specification	Quantity
	Small Animals Interlocking Nail I-LOCK Set	
22.001	Aiming Device For Interlocking Nail	1
22.002	Guiding Rod For Aiming Device	1
22.003	Screwdriver For Locking Bolt T6	1
22.004	Reamer For Proximal End	1
100042	Small Jacobs Chuck With Straight Handle 0-4mm	1
22.006	Sleeve For Temporary Position Pin	4
22.007	Protection Sleeve For Intramedullary Reaming	1
22.008	Protection Sleeve For Locking Bolt Inserting Φ 3.5mm	4
22.009	Drill Sleeve For Locking Bolt Φ 1.5/3.5mm	2
22.010	Drill Sleeve For Locking Bolt Φ 2.0/3.5mm	2
22.011	Allen Key SW4.0	1
22.012	Intramedullary Reamer Φ 3.0mm	1
22.013	Intramedullary Reamer Φ 4.0mm	1
A32A15	Drill Bits 1.5mm	1
A32A20	Drill Bits 2.0mm	1
22.016	Screw Rack For Locking Bolt	1
22.017	Sterilization Box For Interlocking Nail System	1
22.018	Φ 3.0mm Interlocking Nail,Length 60mm	1
22.019	Φ 3.0mm Interlocking Nail,Length 78mm	1
22.020	Φ 3.0mm Interlocking Nail,Length 96mm	1
22.021	Φ 3.0mm Interlocking Nail,Length 114mm	1
22.022	Φ 4.0mm Interlocking Nail,Length 78mm	1
22.023	Φ 4.0mm Interlocking Nail,Length 96mm	1
22.024	Φ 4.0mm Interlocking Nail,Length 114mm	1
22.025	Φ 4.0mm Interlocking Nail,Length 132mm	1
22.026	Locking Bolt Φ 1.5/2.0mm	6
22.027	Locking Bolt Φ 2.0/2.7mm	6

Interlocking Nail I-LOCK System

Protection Sleeve For Locking Bolt Inserting

Veterinary Use Only

Code	Dia
22.008	Φ3.5mm



Drill Sleeve For Locking Bolt

Veterinary Use Only

Code	Dia
22.009	Φ1.5/3.5mm
22.010	Φ2.0/3.5mm



Interlocking Nail

Veterinary Use Only

Titanium Grade 5

Code	Dia	L
22.018	Φ3.0mm	60mm
22.019	Φ3.0mm	78mm
22.020	Φ3.0mm	96mm
22.021	Φ3.0mm	114mm
22.022	Φ4.0mm	78mm
22.023	Φ4.0mm	96mm
22.024	Φ4.0mm	114mm
22.025	Φ4.0mm	132mm



Locking Bolt

Veterinary Use Only

Titanium Grade 5

Code	Dia
22.026	Φ1.5/2.0mm
22.027	Φ2.0/2.7mm



AO Style Small Animal Rush Pin Instruments Set

Open Awl

Veterinary
Use Only

Code	L
ASEN002	180mm



Elastic Nail

Veterinary
Use Only

Titanium
Grade 5

Code	Specification
110015	1.5mm
110018	1.8mm
110020	2.0mm
110025	2.5mm
110030	3.0mm
110035	3.5mm
110040	4.0mm



无锡金诚陈勇医生

Spinal Neurosurgery System



Skull Titanium Mesh System

Titanium Mesh		Veterinary Use Only	Titanium Grade 5
Code	Thickness	L	
604050	0.6mm	40mmX50mm	
605060	0.6mm	50mmX60mm	
606070	0.6mm	60mmX70mm	

Application Of Titanium Mesh In Craniotomy

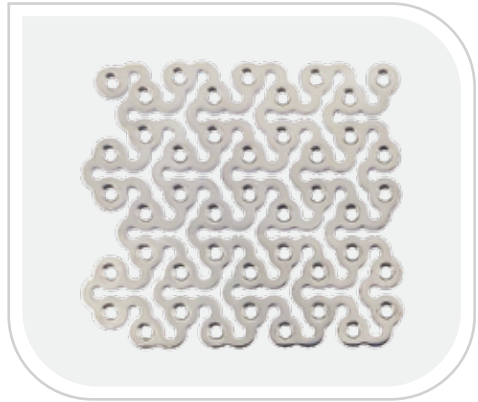
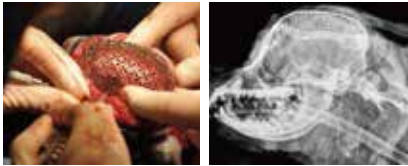

3D Titanium Mesh		Veterinary Use Only	Titanium Grade 5
Code	Thickness	L	
609090	0.6mm	90mmX90mm	



Titanium Mesh Screw		Veterinary Use Only	Titanium Grade 5
Code	Specification		
601504	1.5mmX4.0mm		
601505	1.5mmX5.0mm		
601506	1.5mmX6.0mm		

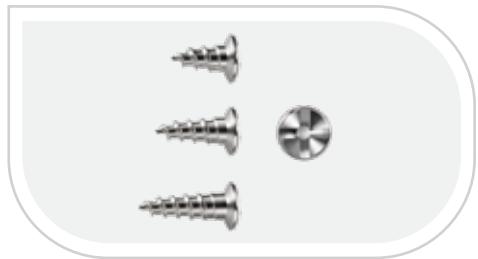

Skull Titanium Mesh System

Safety Limited Depth Drill Bit

Veterinary Use Only

Code	Specification
100402	1.1mmX4mm
100403	1.1mmX5mm
100404	1.1mmX6mm



AO QC Cruciform Screwdriver

Veterinary Use Only

Code	Specification
600075	Titanium Mesh Nail Dedicated



Mini AO QC Handle Screwdriver

Veterinary Use Only

Code	Products Name	L
100399	Mini AO QC Handle	100mm
100401	MiniAOQC Cruciform Screwdriver	55mm



Titanium Mesh Bending Forceps

Veterinary Use Only

Code	L
600076	240mm

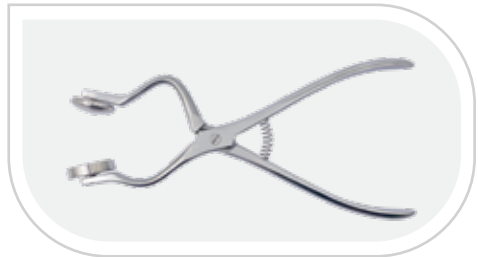

Skull Titanium Mesh System

Titanium Mesh Cutter

Veterinary
Use Only

Code	L
600077	140mm



Cranial Titanium Mesh Sterilization Caddy

Code	Specification
600078	105X170X20mm



Cranial Titanium Mesh System Kit

Code	Products Name/Specification	Quantity
600079	Cranial Titanium Mesh System Kit	
609090	3D Titanium Mesh 0.6mmX90mmX90mm	1
601504	Titanium Mesh Screw 1.5mmX4.0mm	16
601505	Titanium Mesh Screw 1.5mmX5.0mm	16
601506	Titanium Mesh Screw 1.5mmX6.0mm	16
100402	Safety Limited Depth Drill Bit 1.1mmX4mm	1
100403	Safety Limited Depth Drill Bit 1.1mmX5mm	1
100404	Safety Limited Depth Drill Bit 1.1mmX6mm	1
600075	AOQC Cruciform Screwdriver	1
600078	Cranial Titanium Mesh Sterilization Caddy	1

VSS Spinal Fixation System

VSS Polyaxial Pedicle Screws

Veterinary Use Only

Code	Dia	Head L	Shaft L
601608	1.6mm	6.5mm	8mm
601610	1.6mm	6.5mm	10mm
601612	1.6mm	6.5mm	12mm
601614	1.6mm	6.5mm	14mm
602214	2.2mm	6.5mm	14mm
602216	2.2mm	6.5mm	16mm
602218	2.2mm	6.5mm	18mm
602220	2.2mm	6.5mm	20mm
602818	2.8mm	9.5mm	18mm
602821	2.8mm	9.5mm	21mm
602824	2.8mm	9.5mm	24mm
602827	2.8mm	9.5mm	27mm
603524	3.5mm	9.5mm	24mm
603527	3.5mm	9.5mm	27mm
603530	3.5mm	9.5mm	30mm
603533	3.5mm	9.5mm	33mm

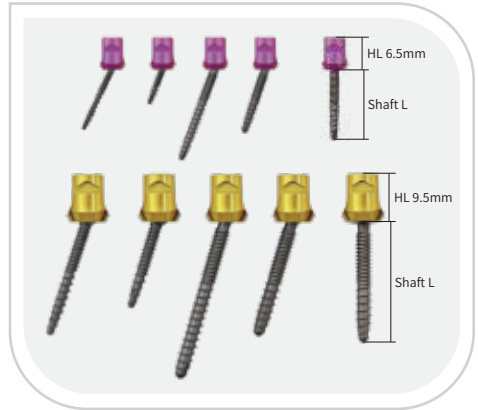

SPF Connecting Rod

Veterinary Use Only

Code	Dia	L
SPF2218	2.2mm	18mm
SPF2224	2.2mm	24mm
SPF2230	2.2mm	30mm
SPF2236	2.2mm	36mm
SPF2242	2.2mm	42mm
SPF2248	2.2mm	48mm
SPF2270	2.2mm	70mm
SPF3228	3.2mm	28mm
SPF3236	3.2mm	36mm
SPF3244	3.2mm	44mm
SPF3252	3.2mm	52mm
SPF3260	3.2mm	60mm
SPF3268	3.2mm	68mm
SPF3299	3.2mm	100mm



VSS Spinal Fixation System

VSS Spinal Fixation Screw Caddy

Veterinary
Use Only

Code Products Name

600051 VSS Spinal Fixation Screw Caddy



VSS Spinal Fixation Set

Code	Products Name/Specification	Quantity
VSS000	VSS Spinal Fixation Set	
600045	Feeler for Screw Channel, Straight L 240mm	1
100160	Straight Quick Couple Handle L 110mm	1
600101	Screwdriver for Polyaxial Pedicle Screw T6	1
600102	Screwdriver for Polyaxial Pedicle Screw T8	1
511.776	Torque Limiting Attachment 0.8Nm	1
511.773	Torque Limiting Attachment 1.5Nm	1
100231	Star Drive Insert AO QC T8	1
100230	Star Drive Insert AO QC T15	1
600103	In-Situ Bending Iron Left/Right	1
ASEN002	Open Awl L 180mm	1
600105	Rod Pusher 2.2mm	1
600106	Rod Pusher 3.2mm	1
600107	Counter Torque 2.5mm	1
600108	Counter Torque 3.5mm	1
600035	Retractor Forceps Opening Range 50-0mm / L 230mm	Optional
600036	Compression Forceps Opening Range 0-45mm / L 210mm	Optional
600052	VSS Spinal Fixation System Sterilization Box	1

Spinal Polyaxial Fixation System

Feeler for Screw Channel, Straight

Veterinary Use Only

Code	L
600045	240mm



Straight Quick Couple Handle

Veterinary Use Only

Code	L
100160	110mm



Screwdriver for Polyaxial Pedicle Screw

Code	Specification
600101	T6
600102	T8



Torque Limiting Attachment

Veterinary Use Only

Code	Specification
511.776	AO QC 0.8Nm
511.773	AO QC 1.5Nm



Star Drive Insert AO QC

Veterinary Use Only

Code	Specification	Use Screw
100231	T8	2,4/2,7mm Locking Screws
100230	T15	3,5mm Locking Screws

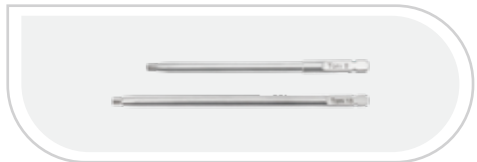

In-Situ Bending Iron

Veterinary Use Only

Code	Specification
600103	Left/Right

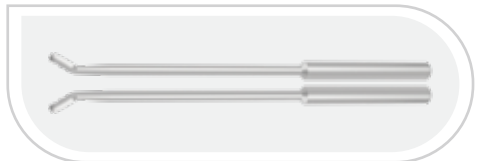

Spinal Polyaxial Fixation System

Open Awl

Veterinary
Use Only

Code	L
ASEN002	180mm



Rod Pusher

Veterinary
Use Only

Code	Specification
600105	2.2mm
600106	3.2mm

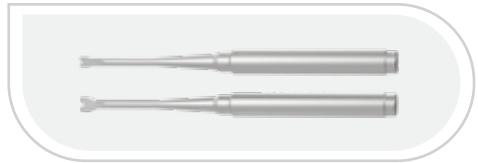

Counter Torque

Veterinary
Use Only

Code	Specification
600107	2.5mm
600108	3.5mm

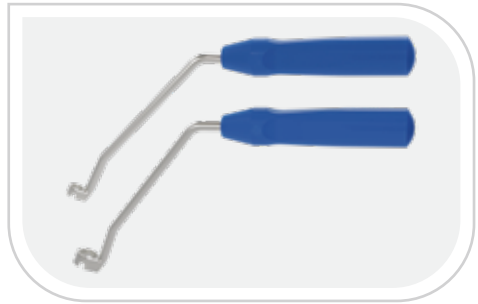

Retractor Forceps (Optional)

Veterinary
Use Only

Code	Opening Range	L
600035	50-0mm	230mm



Compression Forceps (Optional)

Veterinary
Use Only

Code	Opening Range	L
600036	0-45mm	210mm



Spinal Neuro Surgical Instruments

Freer Periosteal Elevator

Veterinary
Use Only

Code	Specification	L
600001	5mm	185mm

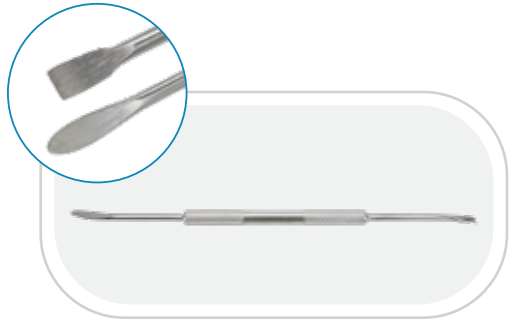

Very Fine Periosteal Elevator

Veterinary
Use Only

Code	Specification	L
600002	2/3mm	180mm

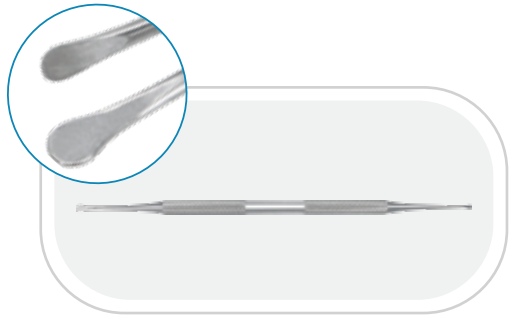

Spinal Hook With Ball Tip

Veterinary
Use Only

Code	L
600003	150mm

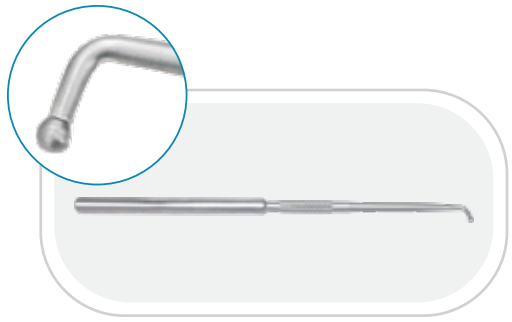

Spinal Neuro Surgical Instruments

Freer Periosteal

Veterinary
Use Only

Code	L
600004	160mm

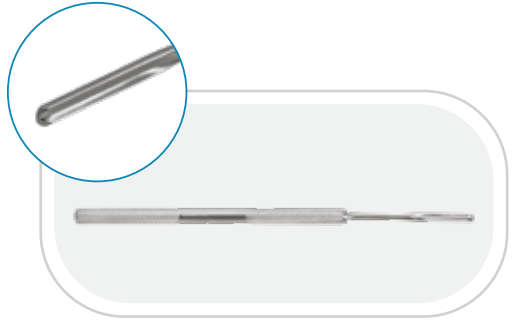

Bone Curette

Veterinary
Use Only

Code	Specification	L
600005	Large 3mm	150mm
600006	Medium 2mm	150mm
600007	Small 1mm	150mm

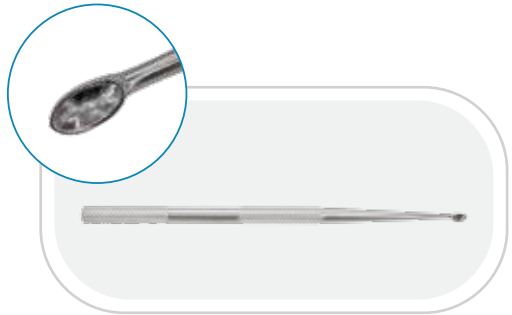

Bone Tamper

Veterinary
Use Only

Code	Specification	L
600008	Large 2mm	150mm
600009	Small 1mm	150mm

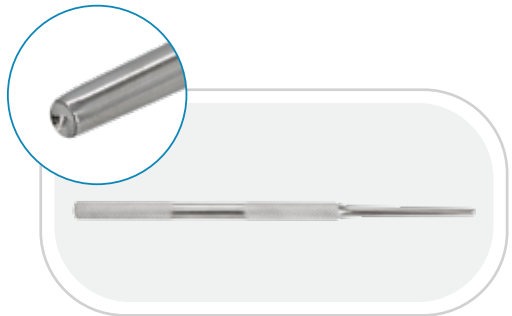

Spinal Neuro Surgical Instruments

Spinal Hook

Veterinary
Use Only

Code	Specification	L
600010	Large	220mm
600011	Small	180mm

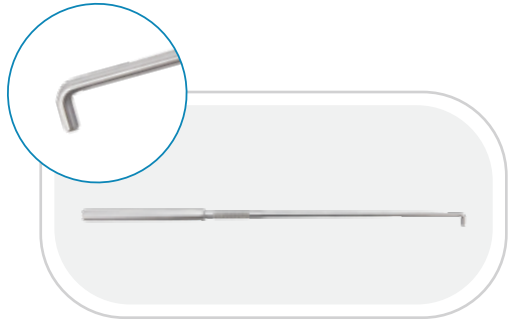

Rosen Mobiliser

Veterinary
Use Only

Code	L
600012	160mm

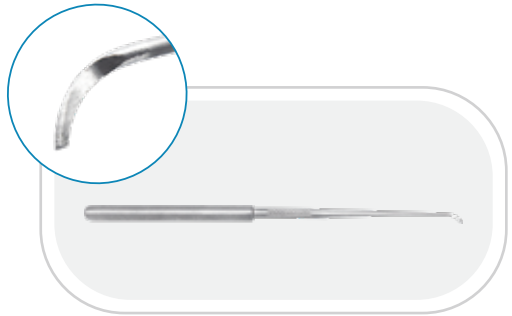

Intervertebral Disc Distractor

Veterinary
Use Only

Code	Depth
600013	90mm



Spinal Neuro Surgical Instruments

Cervical Disc Distractor

Veterinary
Use Only

Code	Specification
600026	0-100mm

For use with Dia 3mm Distraction Screws.



Gelpi With Odd Legs

Veterinary
Use Only

Code	Open Depth	Quantity	L
600270	20X30mm	1 Pair	140mm
600272	25X40mm	1 Pair	180mm

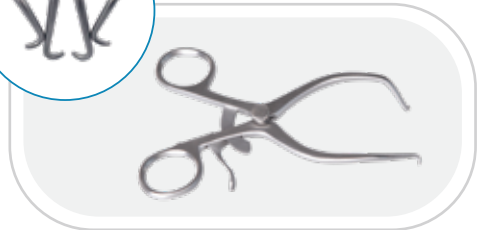
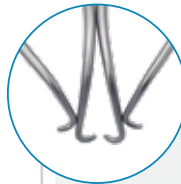

Gelpi With Safe Insertion Legs

Veterinary
Use Only

Code	Leg L	L
600280	20mm	100mm
600281	30mm	135mm
600282	40mm	160mm
600284	50mm	180mm
600285	60mm	200mm

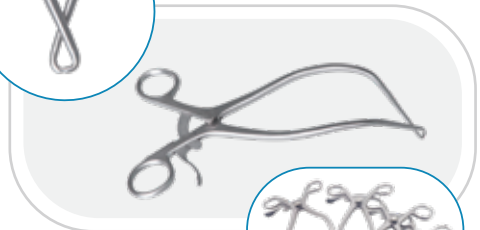

Spinal Neuro Surgical Instruments

Spike&Shield Odd Leg Retractor

Veterinary Use Only

Code	Specification	Quantity	L
600014	22X22mmShield	1 Pair	180mm
600015	12X12mmShield	1 Pair	125mm

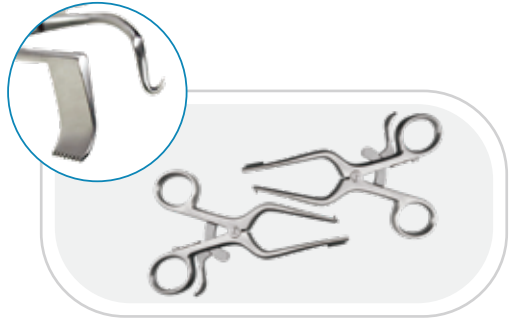

Bone Cement

Veterinary Use Only

Code	Specification
600025	40g



Kerrison Rongeur

Veterinary Use Only

Code	Incision L	L
600016	1mm	200mm
600017	2mm	200mm
600018	3mm	200mm
600019	4mm	200mm
600020	5mm	200mm



Spinal Neuro Surgical Instruments

Micro Spine Rongeur

Veterinary Use Only

Code	Specification	Cutting Width	L
600072	STR	1.75mm	135mm
600073	Angular	1.75mm	135mm
600074	CVD	1.75mm	135mm



BIORTHO Rotating Kerrison Rongeur Handle

Code	Products Name
600033	BIORTHO Rotating Kerrison Rongeur Handle

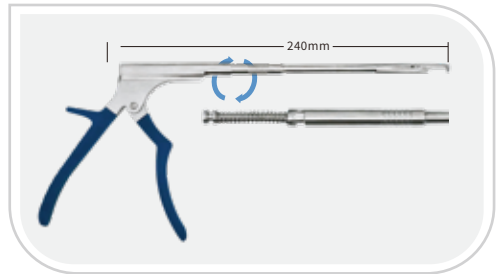

Rotating Kerrison Rongeur

Veterinary Use Only

Code	Angle	Cutting Width	L
600027	90°	1mm	240mm
600028	90°	1.5mm	240mm
600029	90°	2mm	240mm

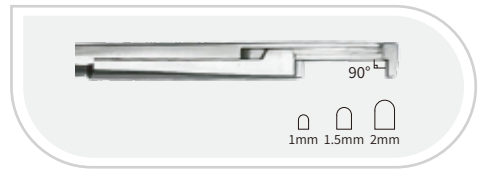

Rotating Kerrison Rongeur

Veterinary Use Only

Code	Angle	Cutting Width	L
600030	130°	1mm	240mm
600031	130°	1.5mm	240mm
600032	130°	2mm	240mm



Pin And Wire



Pin And Wire

Cerclage Wire

Veterinary
Use Only

Stainless Steel
316LVM

Code	Dia
OW0310	0.3mm
OW0510	0.5mm
OW0810	0.8mm
OW1010	1.0mm
OW1210	1.2mm



Wire Passers

Veterinary
Use Only

Code	Dia	Hole Diameter
100047	20mm	0.8mm
100048	30mm	1.2mm



Wire Tightener With Two Cranks

Veterinary
Use Only

Code	L
100050	260mm



Pin And Wire

Cerclage Wire Twisters/Tighteners/Cutter

Veterinary
Use Only

Code	L
100051	150mm

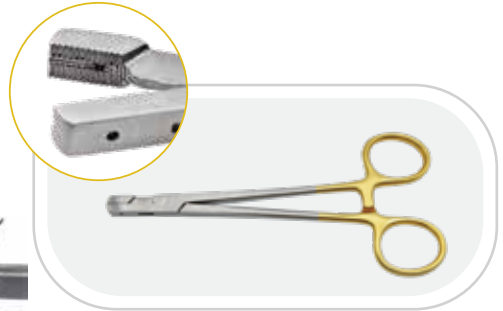

K Wire Pin Punch

Veterinary
Use Only

Code	Specification	Range	L
100052	Small	1.5-2.5mm	135mm
100053	Very Small	0.6-1.6mm	135mm



K Wire Bending Iron

Veterinary
Use Only

Code	Specification	Range
100338	Small	0.8/1.0 1.2/1.5mm
100339	Large	1.6/1.8 2.0/2.5mm

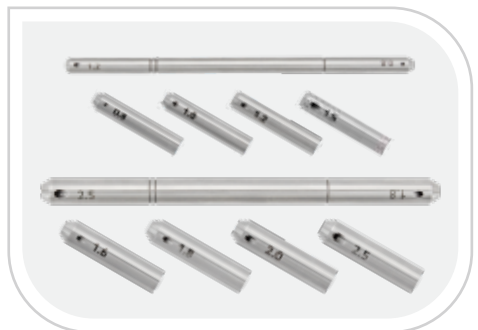

Pin And Wire

Kirschner Wire(Titanium)

Veterinary
Use Only

Code	Dia
PT08	0.8mm
PT10	1.0mm
PT12	1.2mm
PT15	1.5mm
PT20	2.0mm
PT25	2.5mm
PT30	3.0mm
PT35	3.5mm

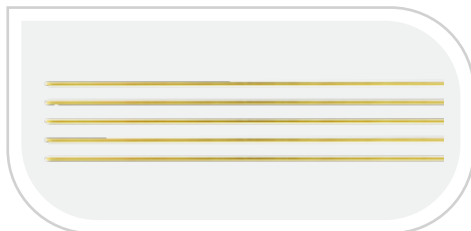

Kirschner Wire - 5Pcs/Pack (Medical stainless steel 316L)

Veterinary
Use Only

Code	Products Name	Dia
PS0825	Single Head Sharp	0.8mm
PS1025	Single Head Sharp	1.0mm
PS1225	Single Head Sharp	1.2mm
PS1525	Single Head Sharp	1.5mm
PS1625	Single Head Sharp	1.6mm
PS1825	Single Head Sharp	1.8mm
PS2025	Single Head Sharp	2.0mm
PS2525	Single Head Sharp	2.5mm
PS3025	Single Head Sharp	3.0mm
PS3525	Single Head Sharp	3.5mm
PS4025	Single Head Sharp	4.0mm

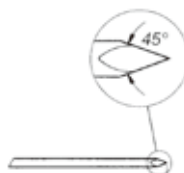
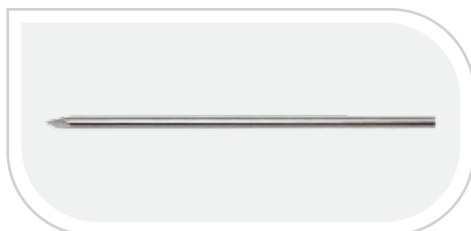

Kirschner Wire - 5Pcs/Pack (Medical stainless steel 316L)

Veterinary
Use Only

Code	Products Name	Dia
PS0825D	Double Head Sharp	0.8mm
PS1025D	Double Head Sharp	1.0mm
PS1225D	Double Head Sharp	1.2mm
PS1525D	Double Head Sharp	1.5mm
PS1825D	Double Head Sharp	1.8mm
PS2025D	Double Head Sharp	2.0mm
PS2525D	Double Head Sharp	2.5mm
PS3025D	Double Head Sharp	3.0mm



Pin And Wire

Kirschner Wire Racks

Veterinary
Use Only

Code	Specification
PB0001	330X140X50mm



K wires/Drill Bits Tube

Veterinary
Use Only

Code	Products Name	L
PT300	K wires Tube	300mm
PT270	K wires Tube	270mm
PT160	Drill Bits Tube	160mm



External Fixation System



Mini External Fixation System

Carbon Fiber Rod

Veterinary Use Only

Code	Dia	L
ROD0360C	3.0mm	60mm
ROD0380C	3.0mm	80mm
ROD03100C	3.0mm	100mm



Titanium Middle Positive Thread Pin

Veterinary Use Only

Code	Thread Dia	Shaft Dia	L
TA091265M	1.2mm	0.9mm	65mm
TA121570M	1.5mm	1.2mm	70mm
TA162080M	2.0mm	1.6mm	80mm
TA202490M	2.4mm	2.0mm	90mm



Titanium End Positive Thread Pin

Veterinary Use Only

Code	Thread Dia	Shaft Dia	L
TA091265E	1.2mm	0.9mm	65mm
TA121570E	1.5mm	1.2mm	70mm
TA162080E	2.0mm	1.6mm	80mm
TA202490E	2.4mm	2.0mm	90mm



Titanium Rod Clamp

Veterinary Use Only

Code	Needle Dia	Specification
EF1015T	1.0-1.5mm	4g



Titanium Rod Clamp

Veterinary Use Only

Code	Needle Dia	Specification
EF1520T	1.5-2.0mm	4g

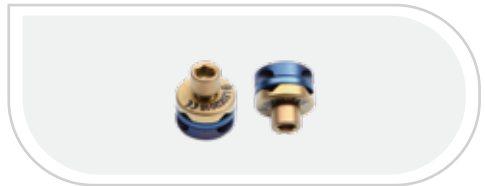

Mini External Fixation System

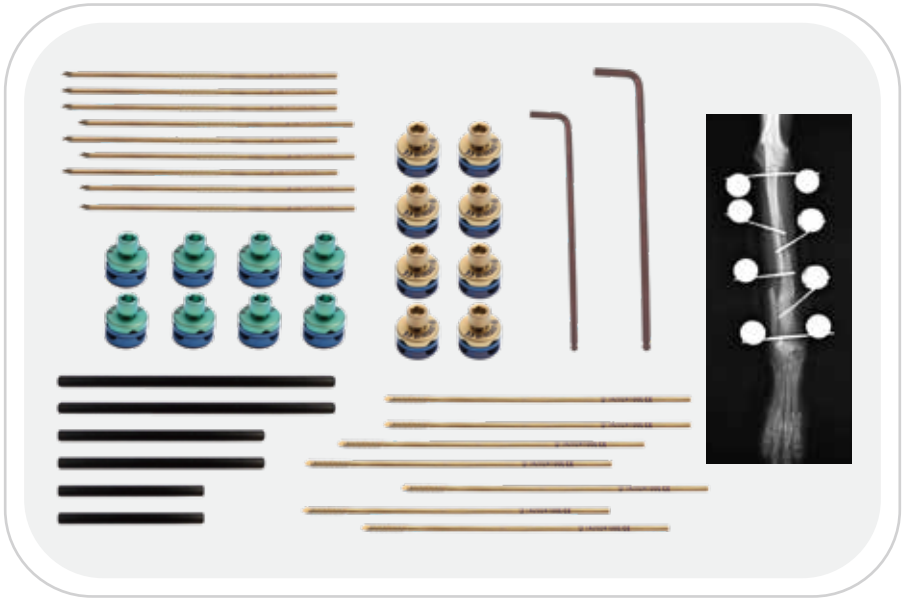

Mini External Fixation System

Code	Products Name/Specification	Quantity
EF1015T	Titanium Rod Clamp 1.0/1.5mm	8
EF1520T	Titanium Rod Clamp 1.5/2.0mm	8
ROD0360C	Carbon Fiber Rod, 3X60mm	2
ROD0380C	Carbon Fiber Rod, 3X80mm	2
ROD03100C	Carbon Fiber Rod, 3X100mm	2
Specification Optional	Titanium Middle Positive Thread Pin	4
Specification Optional	Titanium Bottom Positive Thread Pin	8
EF0001	Rod Clamp Match Allen Key	1

ESF External Fixation

SK Rod Clamp

Veterinary Use Only

Code	Specification
400001	Mini
400002	Medium
400003	Large



SK Double Rod Rod Clamp

Veterinary Use Only

Code	Specification
400014	Mini
400015	Medium
400016	Large



SK Carbon Fiber Rod

Veterinary Use Only

Code	Specification
435050	Small 3.5mmX50mm
435075	Small 3.5mmX75mm
435100	Small 3.5mmX100mm
435125	Small 3.5mmX125mm
435150	Small 3.5mmX150mm
463050	Medium 6.3mmX50mm
463100	Medium 6.3mmX100mm
463150	Medium 6.3mmX150mm
463200	Medium 6.3mmX200mm
463250	Medium 6.3mmX250mm
495050	Large 9.5mmX50mm
495100	Large 9.5mmX100mm
495150	Large 9.5mmX150mm
495200	Large 9.5mmX200mm
495250	Large 9.5mmX250mm
495300	Large 9.5mmX300mm



ESF External Fixation

Sleeve Wrench

Veterinary Use Only

Code	Specification
400100	Small 7mm
400103	Medium 8mm
400106	Large 10mm



Double End Wrench

Veterinary Use Only

Code	Specification
400101	Small 7mm
400104	Medium 8mm
400107	Large 10mm



ESF Drill Sleeve

Veterinary Use Only

Code	Specification
400201	2.2/1.8
400202	3.5/2.8
400203	4.3/3.5



Screw External Fixation Needle Size Reference Table

Medium System

Large System		Small System		
SS4040	SS4030	SS4025	SS4020	SS4010
	SS4035			SS4015
403543E	403240E	402024E	401822E	400912E
		402432E		401115E
		402835E		401418E
403543M	403240M	402024M	401822M	400912M
		402432M		401115M
		402835M		401418M

Note: The shaded part of the dashed line represents overlap.

End Thread Pin

End Thread Pin			Veterinary Use Only	Stainless Steel 316LVM
Code	Shaft/Thread Dia	Pilot hole drill Dia		
SS4010	1.0/1.0mm	0.8mm		
SS4012	1.2/1.2mm	1.0mm		
SS4015	1.5/1.5mm	1.1mm		
SS4018	1.8/1.8mm	1.3mm		
SS4020	2.0/2.0mm	1.5mm		
SS4025	2.5/2.5mm	2.0mm		
SS4030	3.0/3.0mm	2.4mm		
SS4035	3.5/3.5mm	2.7mm		

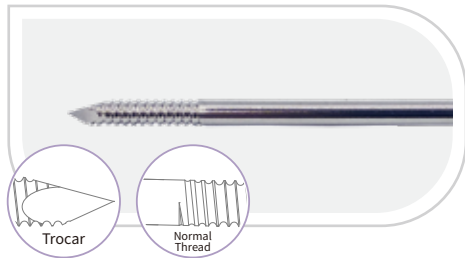

End Positive Thread Pin						Veterinary Use Only	Stainless Steel 316LVM
Code	Shaft/Thread Dia	Pilot hole drill Dia	Thread L	L			
400912E	0.9/1.2mm	0.8mm	12	65mm			
401115E	1.1/1.5mm	1.1mm	12	70mm			
401418E	1.4/1.8mm	1.3mm	15	80mm			
401822E	1.8/2.2mm	1.8mm	15	85mm			
402024E	2.0/2.4mm	2.0mm	17	90mm			
402432E	2.4/3.2mm	2.4mm	25	105mm			
402835E	2.8/3.5mm	2.7mm	35	150mm			
403240E	3.2/4.0mm	3.2mm	32	150mm			
403543E	3.5/4.3mm	3.5mm	45	160mm			

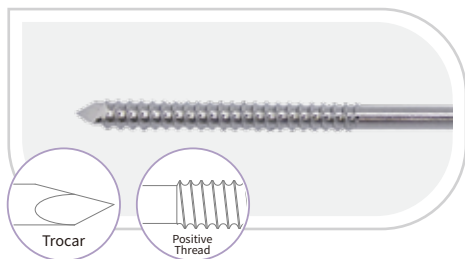

Middle Positive Thread Pin						Veterinary Use Only	Stainless Steel 316LVM
Code	Shaft/Thread Dia	Pilot hole drill Dia	Thread L	L			
400912M	0.9/1.2mm	0.8mm	12	65mm			
401115M	1.1/1.5mm	1.1mm	12	70mm			
401418M	1.4/1.8mm	1.3mm	15	80mm			
401822M	1.8/2.2mm	1.8mm	15	85mm			
402024M	2.0/2.4mm	2.0mm	17	90mm			
402432M	2.4/3.2mm	2.4mm	25	105mm			
402835M	2.8/3.5mm	2.7mm	38	160mm			
403240M	3.2/4.0mm	3.2mm	32	160mm			
403543M	3.5/4.3mm	3.5mm	40	180mm			

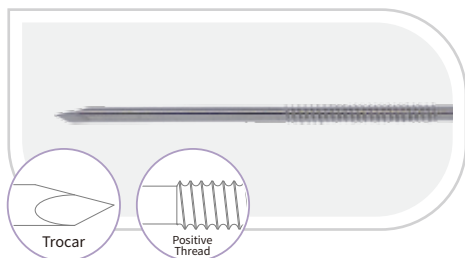

Mini ESF SK Set



Mini ESF SK Starter Set

Code	Products Name/Specification	Quantity
410001	Small ESF SK Starter Set	
400001	Small Pin Rod Clamp	10
400014	Small Double Rod Rod Clamp	2
435075	3.5mmX75mm Carbon Fiber Rod	2
435100	3.5mmX100mm Carbon Fiber Rod	2
435125	3.5mmX125mm Carbon Fiber Rod	2
400100	7mm Sleeve Wrench	1
400101	7mm Double End Wrench	1
Specification Optional	Drill Bits	2
Specification Optional	End Positive Thread Pin	4
Specification Optional	Middle Positive Thread Pin	2



Mini ESF SK Complete Set

Code	Products Name/Specification	Quantity
410011	Small ESF SK Complete Set	
400001	Small Pin Rod Clamp	12
400014	Small Double Rod Rod Clamp	4
435050	3.5mmX50mm Carbon Fiber Rod	2
435075	3.5mmX75mm Carbon Fiber Rod	2
435100	3.5mmX100mm Carbon Fiber Rod	4
435125	3.5mmX125mm Carbon Fiber Rod	2
400100	7mm Sleeve Wrench	2
400101	7mm Double End Wrench	1
Specification Optional	Drill Bits	2
Specification Optional	End Positive Thread Pin	12
Specification Optional	Middle Positive Thread Pin	4
100042	Small Jacobs Chuck With Straight Handle	1

Medium ESF SK Set



Medium ESF SK Starter Set

Code	Products Name/Specification	Quantity
410002	Medium ESF SK Starter Set	
400002	Medium Pin Rod Clamp	10
400015	Medium Double Rod Rod Clamp	2
463100	6.3mmX100mm Carbon Fiber Rod	2
463150	6.3mmX150mm Carbon Fiber Rod	2
463200	6.3mmX200mm Carbon Fiber Rod	2
400103	8mm Sleeve Wrench	1
400104	8mm Double End Wrench	1
Specification Optional	Drill Bits	2
Specification Optional	End Positive Thread Pin	4
Specification Optional	Middle Positive Thread Pin	2



Medium ESF SK Complete Set

Code	Products Name/Specification	Quantity
410012	Medium ESF SK Complete Set	
400002	Medium Pin Rod Clamp	12
400015	Medium Double Rod Rod Clamp	4
463050	6.3mmX50mm Carbon Fiber Rod	2
463100	6.3mmX100mm Carbon Fiber Rod	2
463150	6.3mmX150mm Carbon Fiber Rod	4
463200	6.3mmX200mm Carbon Fiber Rod	2
400103	8mm Sleeve Wrench	2
400104	8mm Double End Wrench	1
Specification Optional	Drill Bits	2
Specification Optional	End Positive Thread Pin	12
Specification Optional	Middle Positive Thread Pin	4
100042	Small Jacobs Chuck With Straight Handle	1

Large ESF SK Set



Large ESF SK Starter Set

Code	Products Name/Specification	Quantity
410003	Large ESF SK Starter Set	
400003	Large Pin Rod Clamp	10
400016	Large Double Rod Rod Clamp	2
495150	9.5mmX100mm Carbon Fiber Rod	2
495200	9.5mmX150mm Carbon Fiber Rod	2
495250	9.5mmX200mm Carbon Fiber Rod	2
400106	10mm Sleeve Wrench	1
400107	10mm Double End Wrench	1
Specification Optional	Drill Bits	2
Specification Optional	End Positive Thread Pin	4
Specification Optional	Middle Positive Thread Pin	2



Large ESF SK Complete Set

Code	Products Name/Specification	Quantity
410013	Large ESF SK Complete Set	
400003	Large Pin Rod Clamp	12
400016	Large Double Rod Rod Clamp	4
495050	9.5mmX50mm Carbon Fiber Rod	2
495100	9.5mmX100mm Carbon Fiber Rod	2
495150	9.5mmX150mm Carbon Fiber Rod	4
495200	9.5mmX200mm Carbon Fiber Rod	2
400106	10mm Sleeve Wrench	2
400107	10mm Double End Wrench	1
Specification Optional	Drill Bits	2
Specification Optional	End Positive Thread Pin	12
Specification Optional	Middle Positive Thread Pin	4
100042	Small Jacobs Chuck With Straight Handle	1

SK External Fixation System



SK External Fixation System Complete Set

Code	Products Name/Specification	Quantity
410000	SK® External Fixation System Complete Set	
400001	Small Pin Rod Clamp	10
400014	Small Double Rod Rod Clamp	2
435075	3.5mmX75mm Carbon Fiber Rod	2
435100	3.5mmX100mm Carbon Fiber Rod	2
435125	3.5mmX125mm Carbon Fiber Rod	2
400101	7mm Double End Wrench	1
400100	7mm Sleeve Wrench	1
Specification Optional	Drill Bits	2
Specification Optional	End Positive Thread Pin	4
Specification Optional	Middle Positive Thread Pin	2
400002	Medium Pin Rod Clamp	10
400015	Medium Double Rod Rod Clamp	2
463100	6.3mmX100mm Carbon Fiber Rod	2
463150	6.3mmX150mm Carbon Fiber Rod	2
463200	6.3mmX200mm Carbon Fiber Rod	2
400104	8mm Double End Wrench	1
400103	8mm Sleeve Wrench	1
Specification Optional	Drill Bits	2
Specification Optional	End Positive Thread Pin	4
Specification Optional	Middle Positive Thread Pin	2
400003	Large Pin Rod Clamp	10
400016	Large Double Rod Rod Clamp	2
495150	9.5mmX100mm Carbon Fiber Rod	2
495200	9.5mmX150mm Carbon Fiber Rod	2
495250	9.5mmX200mm Carbon Fiber Rod	2
400107	10mm Double End Wrench	1
400106	10mm Sleeve Wrench	1
Specification Optional	Drill Bits	2
Specification Optional	End Positive Thread Pin	4
Specification Optional	Middle Positive Thread Pin	2
410000E	Sterilization Case	1

Power Tool System



Spinal Neurosurgery High Speed Drill

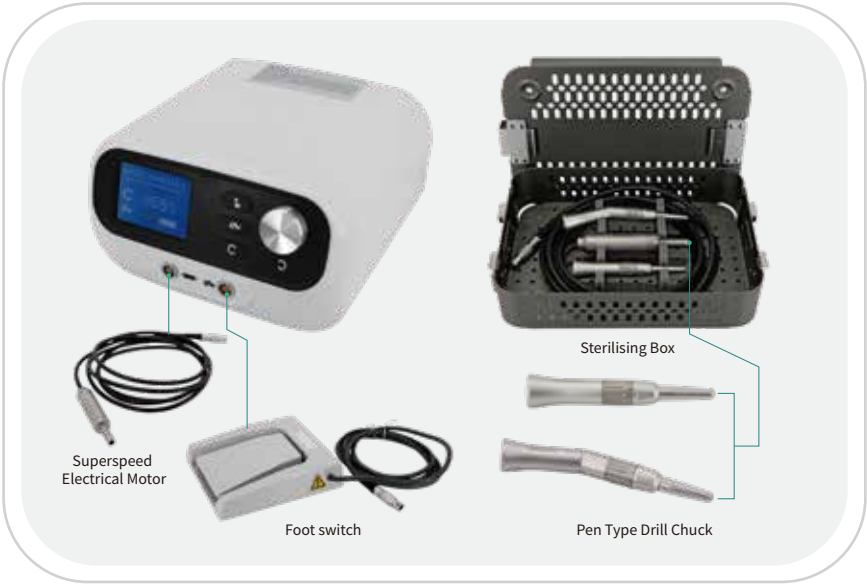

Code	Products Name/Speciiaation
700008	Spinal Neurosurgery High Speed Drill Set

Neurosurgical High Speed Grinding Bur

Code	Products Name	Speciiaation	L
R1070	High Speed Alloy Grinding Bur	1.0mm	70mm
R2070	High Speed Alloy Grinding Bur	2.0mm	70mm
R3070	High Speed Alloy Grinding Bur	3.0mm	70mm
R4070	High Speed Alloy Grinding Bur	4.0mm	70mm
R5070	High Speed Alloy Grinding Bur	5.0mm	70mm
D1070	High Speed Diamond Grinding Bur	1.0mm	70mm
D2070	High Speed Diamond Grinding Bur	2.0mm	70mm
D3070	High Speed Diamond Grinding Bur	3.0mm	70mm
D4070	High Speed Diamond Grinding Bur	4.0mm	70mm
D5070	High Speed Diamond Grinding Bur	5.0mm	70mm

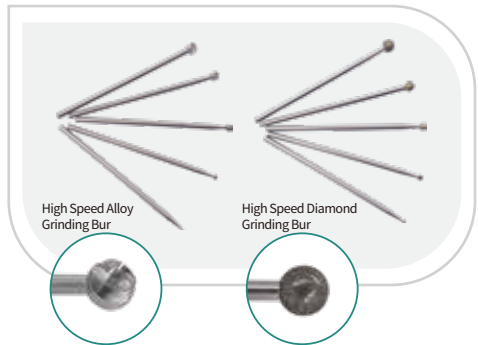

BW7.2V Cannulated Drill

BW 7.2V Cannulated Drill Set

Veterinary
Use Only

Code	Speciliaation
700001	BW7.2V



BW 7.2V Battery

Veterinary
Use Only

Code	Speciliaation
700010	BW7.2V



BW 7.2V Battery Chargers

Veterinary
Use Only

Code	Speciliaation
700011	BW7.2V



BW 7.2V Drill key

Veterinary
Use Only

Code	Speciliaation
700023	BW7.2V



BW7.2V Battery Powered Saw

BW 7.2V Battery Powered Saw

Veterinary
Use Only

Code	Specilaation
700002	BW7.2V



BW Series Saw Blades

Veterinary
Use Only

Code	Incision Thickness	Width	L
700114	0.3mm	5mm	35mm
700165	0.3mm	6mm	45mm
700180	0.3mm	8mm	45mm
700110	0.4mm	10mm	50mm
700112	0.4mm	12mm	50mm
700116	0.5mm	15mm	60mm
700119	0.5mm	20mm	60mm

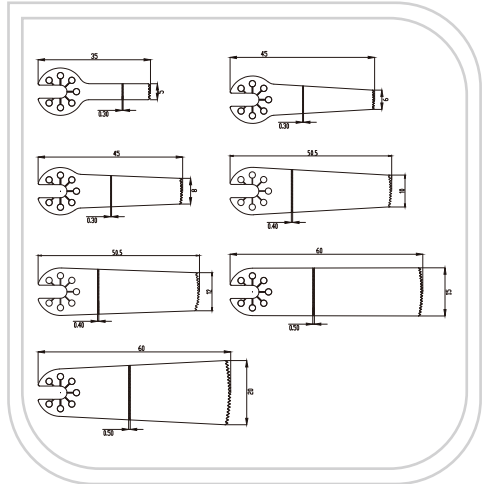

BW7.2V Multi-Function Drill

BW 7.2V Multi-Function Drill (Drill only)

Veterinary
Use Only

Code	Speciliaation
700003	BW7.2V



Cannulated Jacob Attachment

Veterinary
Use Only

Code
700013



AO QC Attachment

Veterinary
Use Only

Code
700014



Sagittal Saw Attachment

Veterinary
Use Only

Code
700015



K Wire Chuck Attachment

Veterinary
Use Only

Code	Dia
700016	0.8-2.5mm



BW7.2V Multi-Function Drill

BW 7.2V Battery

Veterinary
Use Only

Code	Specification
700010	BW7.2V



BW 7.2V Battery Chargers

Veterinary
Use Only

Code	Specification
700011	BW7.2V



Sterilization Case

Veterinary
Use Only

Code
700012



BW7.2V Multi-Function Drill

Code	Products Name/Specification	Quantity
700003	BW 7.2V Hand Piece Cannulated 0-2.5mm	1
700013	Cannulated Jacob Attachment	1
700014	AO QC Attachment	1
700015	Sagittal Saw Attachment	1
700016	K Wire Chuck Attachment 0.8-2.5mm	1
700010	BW 7.2V Battery	2
700011	BW 7.2V Battery Chargers	1
700012	Sterilization Case	1

BW7.4V Multi-Function Lithium Battery Drill

BW7.4V Multi-Function Lithium Battery Drill (Drill only)

Code	Speciliaation
700050	BW7.4V

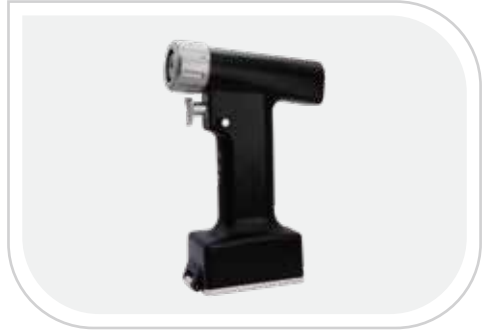

Cannulated Jacob Attachment

Veterinary Use Only

Code
700051



AO QC Attachment

Veterinary Use Only

Code
700052



Sagittal Saw Attachment

Veterinary Use Only

Code
700053



K Wire Chuck Attachment

Veterinary Use Only

Code	Dia
700054	0.8-2.5mm



BW7.4V Multi-Function Lithium Battery Drill

BW 7.4V Lithium Battery		Veterinary Use Only
Code	Speciliaation	
700056	BW7.4V	



Battery Chargers		Veterinary Use Only
Code	Speciliaation	
700055	BW7.4V	



Sterilization Case		Veterinary Use Only
Code		
700012		



BW7.4V Multi-Function Drill		
Code	Products Name/Speciliaation	Quantity
700050	BW7.4V Multi-Function Lithium Battery Drill	1
700051	Cannulated Jacob Attachment	1
700052	AO QC Attachment	1
700053	Sagittal Saw Attachment	1
700054	K Wire Chuck Attachment 0.8-2.5mm	1
700056	BW 7.4V Battery	2
700055	BW 7.4V Battery Chargers	1
700012	Sterilization Case	1

BW14.4V Cannulated Drill

BW 14.4V Cannulated Drill Set

Veterinary
Use Only

Code	Specification
700004	BW14.4V



BW 14.4V Battery

Veterinary
Use Only

Code	Specification
700020	BW14.4V



BW 14.4V Battery Chargers

Veterinary
Use Only

Code	Specification
700021	BW14.4V



BW 14.4V Drill key

Veterinary
Use Only

Code	Specification
700024	BW14.4V



BW14.4V Battery Powered Saw

BW 14.4V Battery Powered Saw		Veterinary Use Only
Code	Specilisation	
700005	BW14.4V	



14.4V Drill Sterilization Case		Veterinary Use Only
Code		
700022		

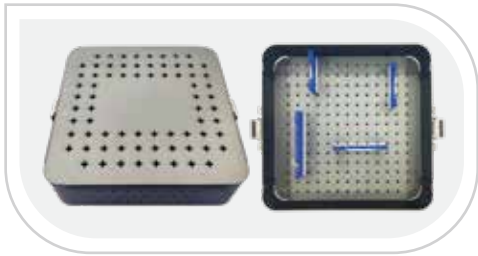

UNIUM & Colibri II Saw Blades				Veterinary Use Only
Code	Incision Thickness	Width	L	
700101	0.4mm	6mm	42mm	
700102	0.4mm	10mm	46mm	
700103	0.5mm	14mm	65mm	
700104	0.6mm	20mm	65mm	

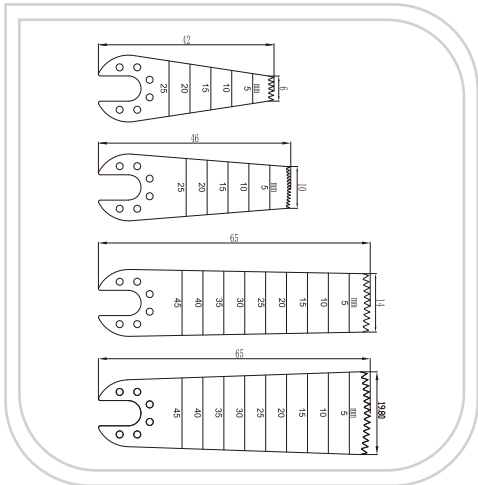

TPLO SAW

TPLO Saw

Veterinary
Use Only

Code

001.204



TPLO Battery

Veterinary
Use Only

Code

532.104



TPLO Battery Charger

Veterinary
Use Only

Code

532.010



TPLO Saw Sterilization Box

Veterinary
Use Only

Code

532.026



Wrench For Saw Balde Tightening Nut

Veterinary
Use Only

Code

532.027



Replacement Jig Pin Screw

Veterinary
Use Only

Code

B0002.04

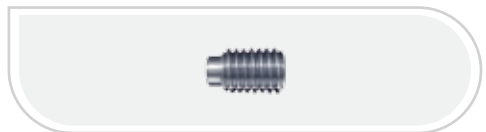

TPLO Related Instruments

TPLO Saw Blades		Veterinary Use Only
Code	Specification	
000.390	8mm Radius	
000.391	10mm Radius	
000.392	12mm Radius	
000.393	15mm Radius	
000.394	18mm Radius	
000.395	21mm Radius	
000.396	24mm Radius	
000.397	27mm Radius	

TPLO Saw Blades		Veterinary Use Only
Code	Specification	
000.389	6mm Radius	
000.341	7mm Radius	
000.340	9mm Radius	
000.398	30mm Radius	
000.399	33mm Radius	

TPLO Saw Blade Adapter		Veterinary Use Only
Code		
100332		

● Designed to couple BIORTHO TPLO saw blades to Synthes Colibri Tplo saw.



TPLO Saw Set			
Code	Products Name/Specification	Quantity	
05.001.204	TPLO Saw	1	
532.104	TPLO Battery	2	
532.010	TPLO Battery Charger	1	
03.000.396	24mm Radius TPLO Saw Blades	1	
03.000.397	27mm Radius TPLO Saw Blades	1	
532.026	TPLO Saw Sterilization Box	1	

Soft Tissue Instruments



Basic Surgical Operating Instrument

Mayo Safety Pin

Veterinary Use Only

Code	L
500000	140mm



Crile Artery Forceps

Veterinary Use Only

Code	Speciliaation	L
500004	Straight	140mm
500003	Curved	140mm
500005	Straight	160mm
500006	Curved	160mm



Halsted-Mosquito

Veterinary Use Only

Code	Speciliaation	L
500001	Straight	125mm
500002	Curved	125mm



Basic Surgical Operating Instrument

Allis Tissue Forceps

Veterinary
Use Only

Code	Speciliaation	L
500007	4X5 Teeth	150mm
510007	4X5 Teeth	125mm

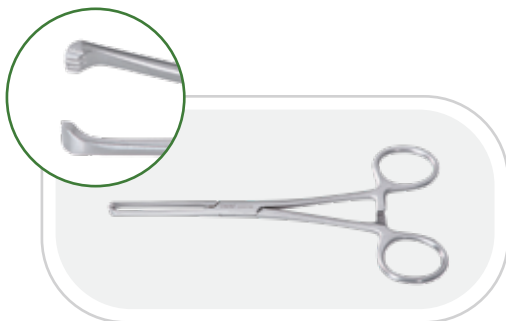

Dressing-Blunt/Sharp

Veterinary
Use Only

Code	Speciliaation	L
500008	Straight	145mm
500009	Curved	145mm

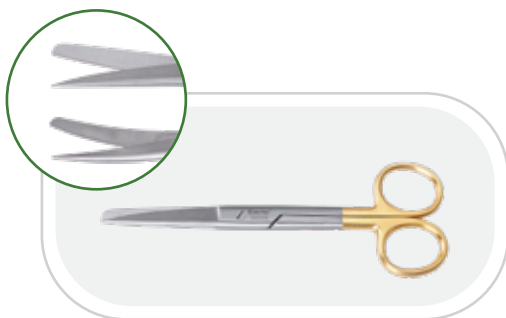

Dressing-Sharp/Sharp

Veterinary
Use Only

Code	Speciliaation	L
500010	Straight	145mm
500011	Curved	145mm
500039	Straight	165mm
500040	Curved	165mm
500041	Straight	115mm
500042	Curved	115mm

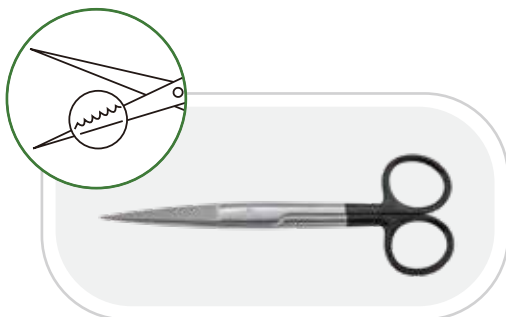

Basic Surgical Operating Instrument

Operating Scissors Blunt

Veterinary Use Only

Code	Speciliaation	L
500043	Straight	145mm
500044	Curved	145mm
500045	Straight	165mm
500046	Curved	165mm

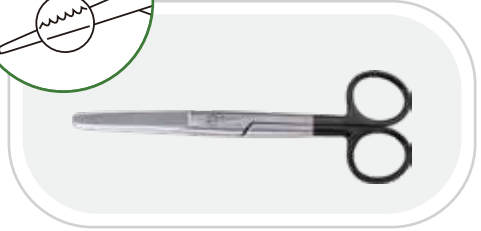
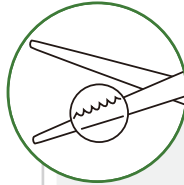

Stitch-Cutting Scissors

Veterinary Use Only

Code	L
500047	150mm

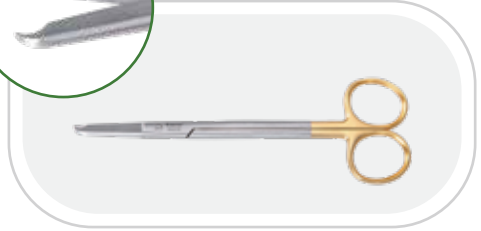

Metzenbaum Supercut T.C

Veterinary Use Only

Code	Speciliaation	L
500013	Straight	145mm
500014	Curved	145mm

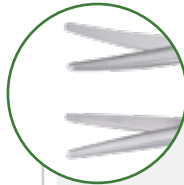

Basic Surgical Operating Instrument

Surgical Scissor-Supercut T.C

Veterinary
Use Only

Code	Speciliaation	L
500015	Straight	150mm
500016	Curved	150mm

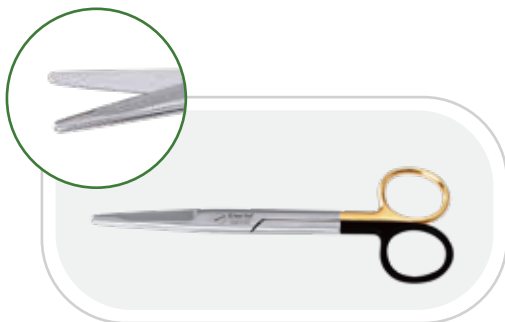

Goldmann Fox T.C Supercut

Veterinary
Use Only

Code	Speciliaation	L
500048	Straight tip	130mm

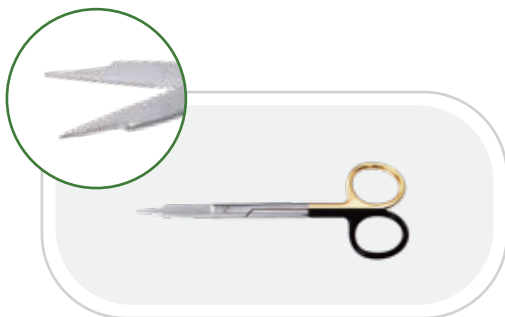

Iris Scissors

Veterinary
Use Only

Code	Speciliaation	L
500012	Straight tip	115mm

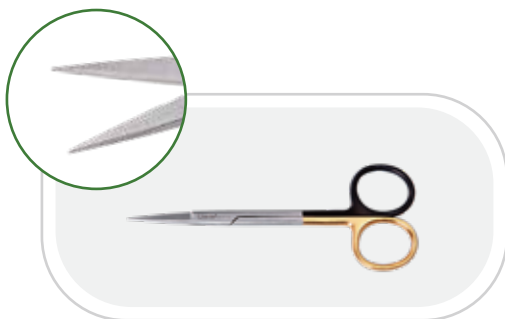

Basic Surgical Operating Instrument

Bandage Scissor

Veterinary Use Only

Code	L
500074	150mm
500075	180mm

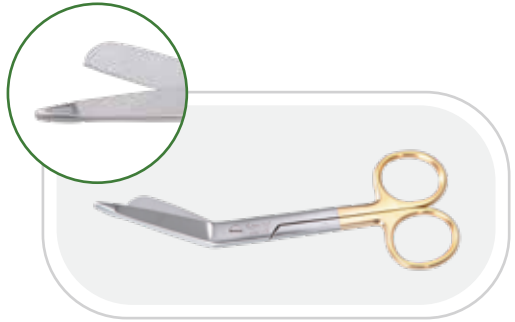

Mayo Hegar T.C. Jaws (3mm Width)

Veterinary Use Only

Code	L
500017	125mm
500018	140mm
500019	160mm

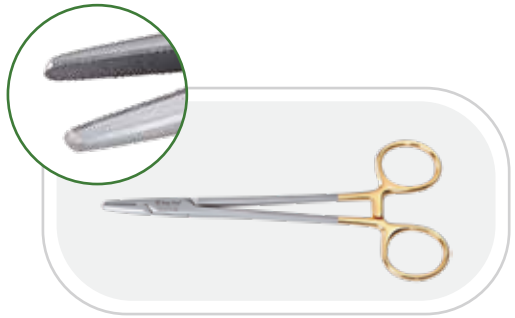

Ryder (Micro) T.C. Jaws

Veterinary Use Only

Code	L
500020	150mm
500021	135mm

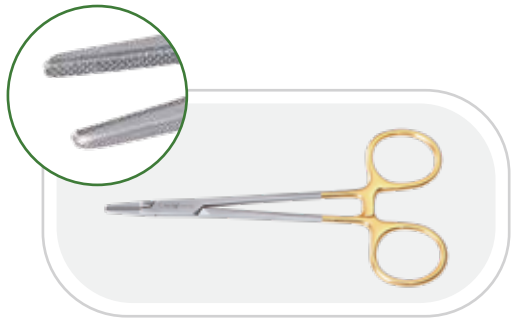

Basic Surgical Operating Instrument

Olsen Hegar Needle Holders "s"cut
T.C.Jaws

Veterinary
Use Only

Code	L
500022	140mm
500023	160mm

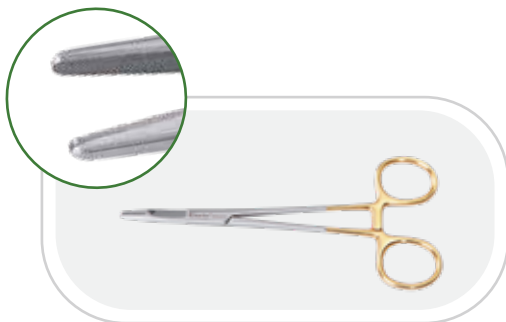

Gillies Olsen Hegar Needle Holders

Veterinary
Use Only

Code	Speciliaation	L
500049	Right Hand	160mm
500050	Left Hand	160mm



Basic Surgical Operating Instrument

Dissecting Forceps

Veterinary Use Only

Code	Specification	L
500024	1*2 Hooks	150mm
500024b	Transverse Teeth	150mm

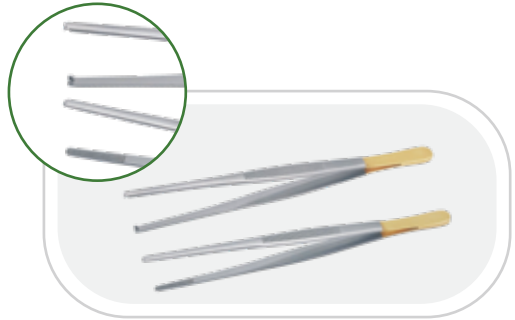

DeBakey Dessecting Forceps

Veterinary Use Only

Code	Specification	L
500027	Transverse Teeth	125mm
500027b	1*2 Hooks	125mm



Adson Forceps

Veterinary Use Only

Code	Specification
500028	Transverse Teeth Forceps
500029	1*2 Hooks Forceps
500030	Debakey Forceps
500031	Brown Forceps
500076	Tissue Forceps



Basic Surgical Operating Instrument

Standard Scalpel Handles

Veterinary
Use Only

Code	Specilisation
500036	NO-3
500037	NO-4

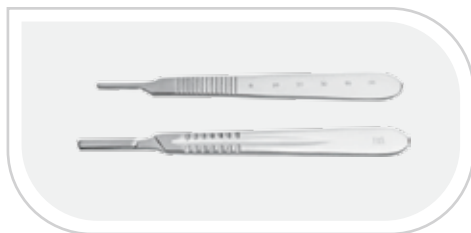

Surgical Blade

Veterinary
Use Only

Code	Specilisation	Scalpel Handles
SB0310	NO.10	NO.3
SB0311	NO.11	NO.3
SB0312	NO.12	NO.3
SB0315	NO.15	NO.3
SB0421	NO.21	NO.4
SB0423	NO.23	NO.4



Basic Surgical Operating Instrument

Backhuas Towel Forceps

Veterinary
Use Only

Code	L
500032	100mm
500033	125mm

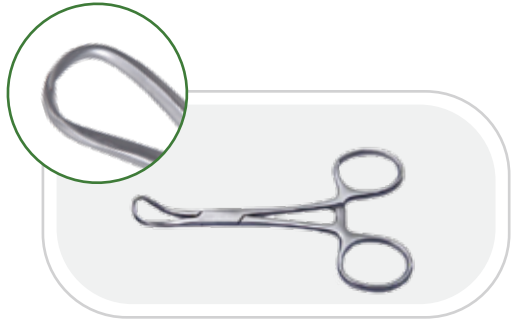

Ball and Socket Towel Clamp

Veterinary
Use Only

Code	L
500035	125mm

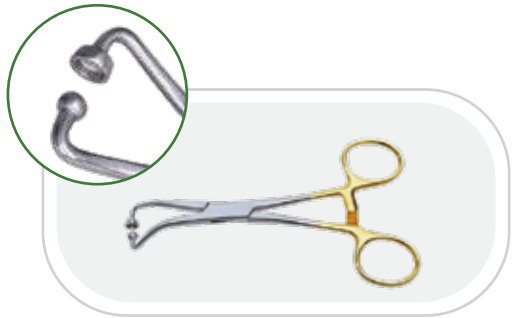

Jones Towel Forceps

Veterinary
Use Only

Code	L
500038	90mm



Basic Surgical Operating Instrument

Intestinal Clamp

Veterinary
Use Only

Code	Speciliaation	L
500051	Straight	220mm
500052	Curved	220mm

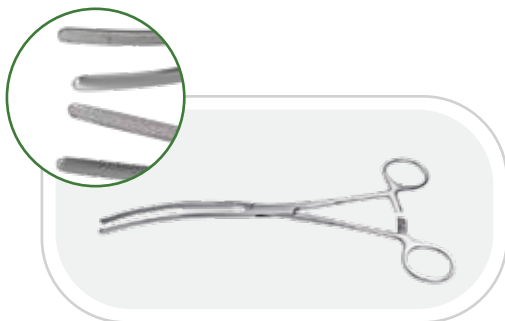

Hysterectomy Clamps (Carmault)

Veterinary
Use Only

Code	L
500081	160mm
500082	200mm



Baby satinsky

Veterinary
Use Only

Code	L
500068	150mm

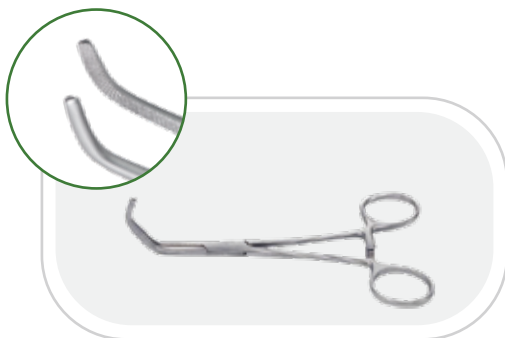

Basic Surgical Operating Instrument

Soft Palate Forceps

Veterinary Use Only

Code	Specification
500070S	18X7X170mm
500070L	26X12X170mm

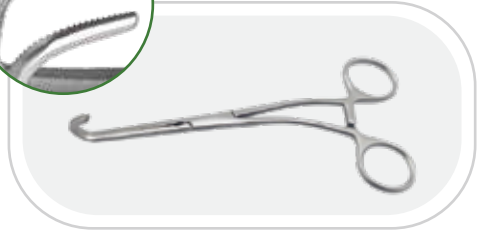

GEMINI hemostatic forceps

Veterinary Use Only

Code	L
500083	155mm
500084	250mm

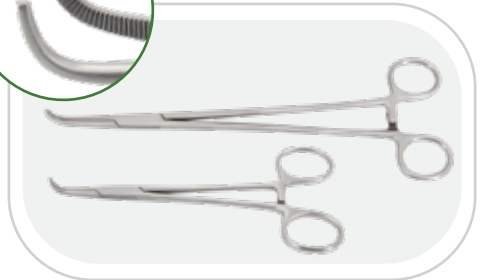

Spay Forceps With Hook

Veterinary Use Only

Code	L
500065	140mm
500066	160mm

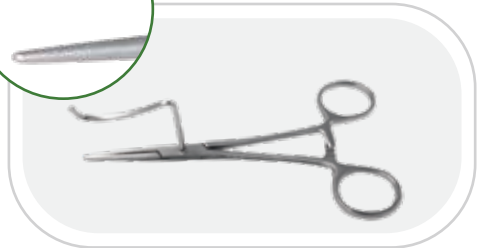

Basic Surgical Operating Instrument

Spay Hook

Veterinary
Use Only

Code	Speciliaation	L
500061	For Dogs	180mm
500062	For Cats	150mm



Mouth Gags for Cats

Veterinary
Use Only

Code	Speciliaation	Opening Range
500054	Small	25mm-75mm
500055	Medium	30mm-100mm
500056	Large	30mm-145mm

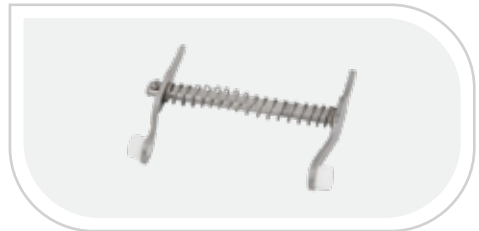

Mouth Gags for Dogs

Veterinary
Use Only

Code	Speciliaation	Opening Range
500057	Small	40mm-90mm
500058	Medium	40mm-110mm
500059	Large	50mm-170mm



Tongue Forceps

Veterinary
Use Only

Code	L
500053	170mm



Basic Surgical Operating Instrument

Gosset Retractors

Veterinary
Use Only

Code	Maximum Opening Range
500063	100mm



Balfour Retractors

Veterinary
Use Only

Code	Maximum Opening Range
500064S	120mm
500064	180mm

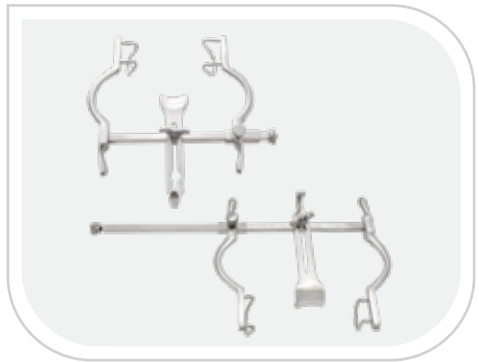

West Retractors

Veterinary
Use Only

Code	Maximum Opening Range
500067	140mm



Gelpi Self Retaining Retractor

Gelpi Self Retaining Retractor

Veterinary
Use Only

Code	L
100148	100mm
100149	140mm
100150	160mm

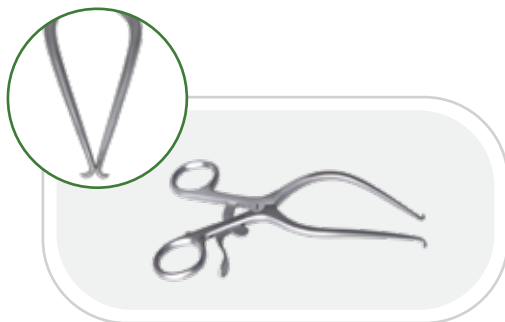

Gelpi Precision Model

Veterinary
Use Only

Code	L
100316	135mm

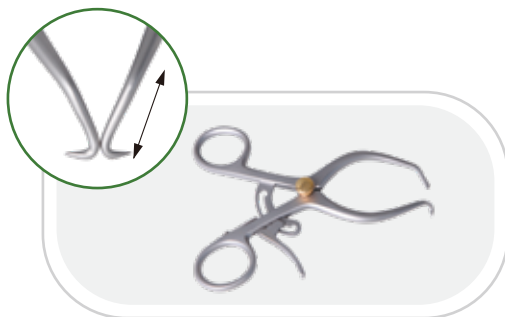

Gelpi With Odd Legs

Veterinary
Use Only

Code	Open Depth	Quantity	L
600270	20X30mm	1 Pair	140mm
600272	25X40mm	1 Pair	180mm

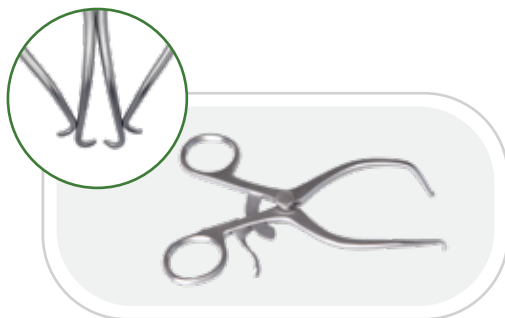

Gelpi Self Retaining Retractor

Gelpi With Safe Insertion Legs

Veterinary Use Only

Code	Leg L	L
600280	20	100mm
600281	30	135mm
600282	40	160mm
600284	50	180mm
600285	60	200mm

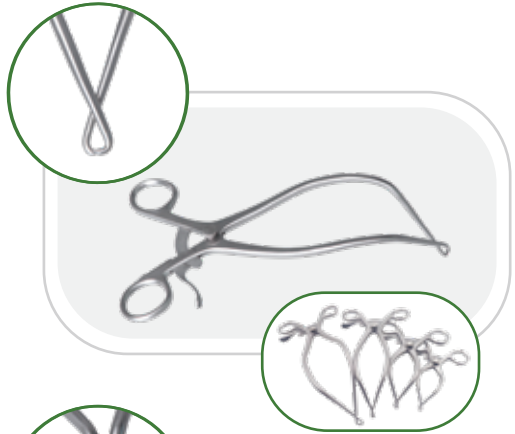

Curved Gelpi Self Retaining Retractor

Veterinary Use Only

Code	Speciliaation	L
100152	Curved	140mm

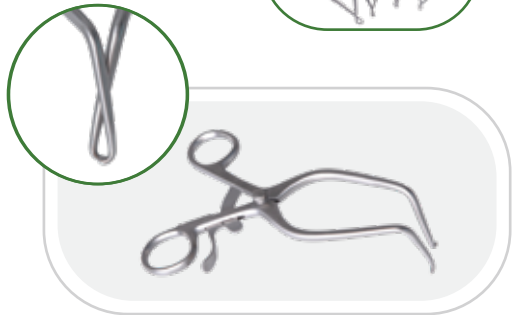

Weislander Self Retaining Retractor

Veterinary Use Only

Code	L
100153	140mm
100154	160mm
100155	180mm

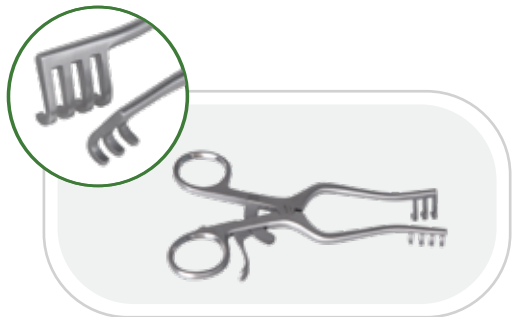

Gelpi Self Retaining Retractor

West's Self Retaining Retractor

Veterinary
Use Only

Code	L
100156	140mm
100157	160mm
100158	180mm

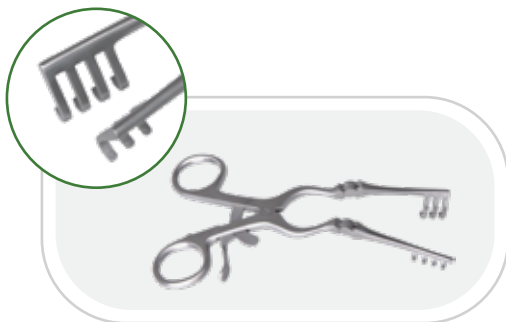

Mini Soft Tissues Self Retaining Retractor

Veterinary
Use Only

Code	Range	L
110200	0-25mm	100mm



Senn Retractor

Veterinary
Use Only

Code	Specification
110156	Sharp
110157	Blunt

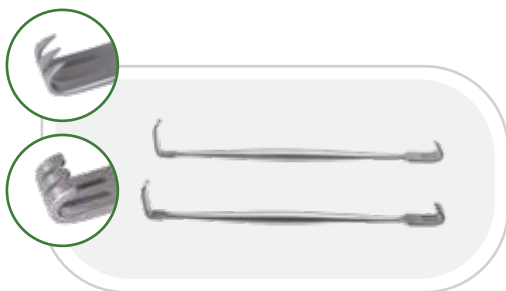

Gelpi Self Retaining Retractor

Joseph Retracting Hooks

Veterinary
Use Only

Code	Specification
100199	160mmX3mm
100203	160mmX6mm



Double Deep Retractor

Veterinary
Use Only

Code	Specification
100204	200X40X20mm



Soft Tissue Surgical Instruments Kit



Soft Tissue Surgical Instruments Kit A

Code	Products Name/Speciaiaation	Quantity
000012	Soft Tissue Surgical Instruments Kit A	
500000	Mayo Safety Pin	1
500005	Crile Artery Forceps-Straight 160/140	3
500006	Crile Artery Forceps-Curved 160/140	3
500007	Allis Tissue Forceps	2
500033	Backhuas Towel Forceps 125/100	4
500039	Dressing	1
500013	Metzenbaum Supercut T.C-Straight 140mm	1
500014	Metzenbaum Supercut T.C-Curved 140mm	1
500019	Mayo Hegar T.C..Jaws 160/140	1
500028	Adson Transverse Teeth Forceps	1
500029	Adson Dissecting Forceps 1*2 Hooks	1
500036	Standard Scalpel Handles No.3/No.4	1
200003	Sterilization Case	1



Soft Tissue Surgical Instruments Kit B

Code	Products Name/Speciaiaation	Quantity
000013	Soft Tissue Surgical Instruments Kit B	
500000	Mayo Safety Pin	1
500006	Crile Artery Forceps-Curved 160/140	4
500001	Halsted-Mosquito-Straight 125	2
500002	Halsted-Mosquito-Curved 125	2
500007	Allis Tissue Forceps	2
500035	Ball and Socket Towel Clamp 125	4
500039	Dressing	1
500015	Surgical Scissor-Supercut T.C.-Straight 150mm	1
500014	Metzenbaum Supercut T.C-Curved 140mm	1
500048	Iris Scissors Straight/Sharp 115mm	1
500023	Olsen Hegar Needle holders's'cut T.C..Jaws 160/140	1
500028	Adson Transverse Teeth Forceps	1
500029	Adson Dissecting Forceps 1*2 Hooks	1
500031	Adson Brown Dissecting Forceps	1
500036	Standard Scalpel Handles NO.3/NO.4	1
200003	Sterilization Case	1

Spay Kit



Canine Spay Kit

Code	Products Name/Speciaiaation	Quantity
000014	Canine Spay Kit	
500015	Surgical Scissor Supercut T.C.Straight 150mm	1
500004	Crile Artery Forceps Straight 140mm	2
500006	Crile Artery Forceps Curved 160mm	2
500002	Halsted Mosquito Curved 125mm	2
500038	Jones Towel Forceps 90mm	4
500007	Allis Tissue Forceps 150mm	2
500024	Dissecting Forceps 1/2 Teeth Ring Gold	1
500023	Olsen Hegar Needle holders's"cut T.C.Jaws 160mm	1
500031	Adson Serrated Dissecting Forceps	1
500036	Standard Scalpel Handles No.3/No.4	1
500061	Spay Hook	1
200003	Sterilization Case	1



Feline Spay Kit

Code	Products Name/Speciaiaation	Quantity
000014F	Feline Spay Kit	
500013	Metzenbaum Supercut T.C.Straight 140mm	1
500006	Crile Artery Forceps Curved 160mm	2
500004	Crile Artery Forceps Straight 140mm	2
500002	Halsted Mosquito Curved 125mm	2
510007	Allis Tissue Forceps 125mm	2
500038	Jones Towel Forceps 90mm	4
500024	Dissecting Forceps 1/2 Teeth Ring Gold	1
500022	Olsen Hegar Needle holders's"cut T.C.Jaws 140mm	1
500031	Adson Brown Dissecting Forceps	1
500062	Spay Hook	1
500036	Standard Scalpel Handles NO-3/NO-4	1
200003	Sterilization Case	1

Sterilization Box

Sterilization Box		Veterinary Use Only
Code	Products Name	Specification
200003	Sterilization Box(Red)	275X165X50mm
2000031	Sterilization Box(Green)	275X165X50mm
2000032	Sterilization Box(Golden)	275X165X50mm
2000033	Sterilization Box(Blue)	275X165X50mm



Sterilization Box		Veterinary Use Only
Code	Specification	
200001	250X200X50mm	



Instruments Sterilization Basket		Veterinary Use Only
Code	Specification	
200005	265X120X70mm	



Sterlization Box

Sterlization Box		Veterinary Use Only
Code	Speciliation	
200002	350X250X150mm	



Sterlization Box		Veterinary Use Only
Code	Speciliation	
200004	300X180X105mm	

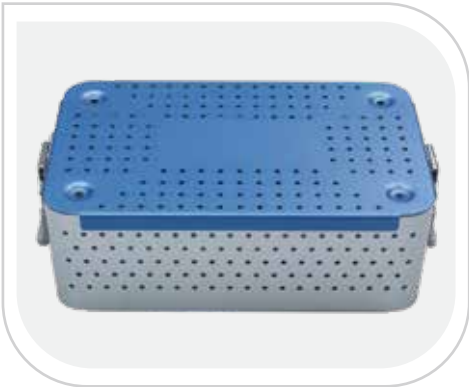

Dental Instruments



Dental Instruments

Sickle Scaler		Veterinary Use Only
Code	L	
800001	170mm	

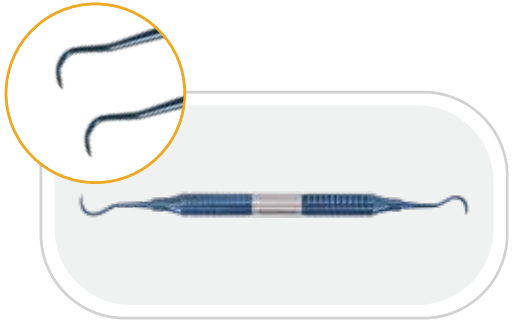

Very Fine Periosteal Elevator			Veterinary Use Only
Code	Cutting Edge	L	
800002	2/4mm	170mm	

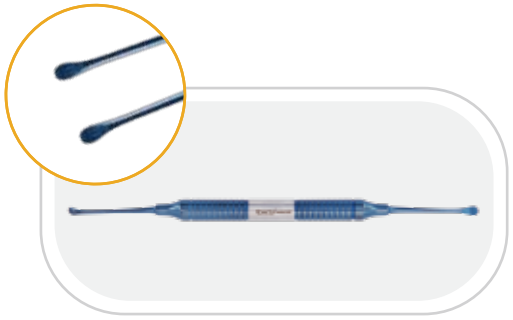

Explorer/Measuring Probe		Veterinary Use Only
Code	L	
800003	170mm	

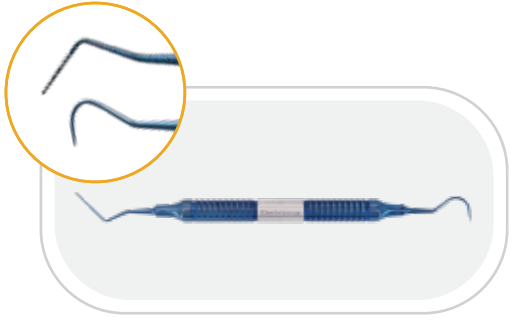

Dental Instruments

Jaquette Supragingival Scaler

Veterinary
Use Only

Code L

800004 170mm

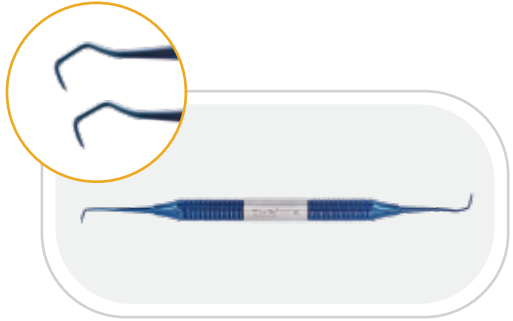

Subgingival Curette

Veterinary
Use Only

Code L

800005 170mm

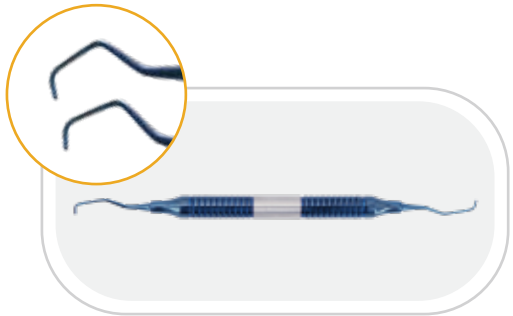

Tartar Removing Forceps

Veterinary
Use Only

Code L

800006 125mm

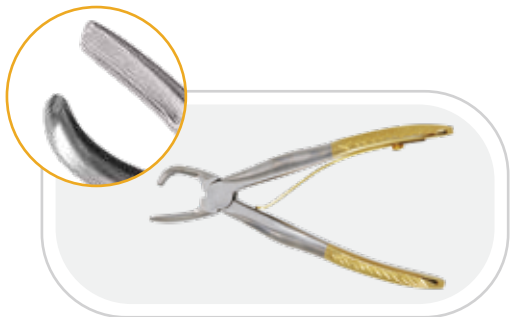

Dental Instruments

Extraction Forceps

Veterinary
Use Only

Code	L
800007	125mm
800007s	115mm



Fragment Extraction Forceps

Veterinary
Use Only

Code	L
800015	140mm

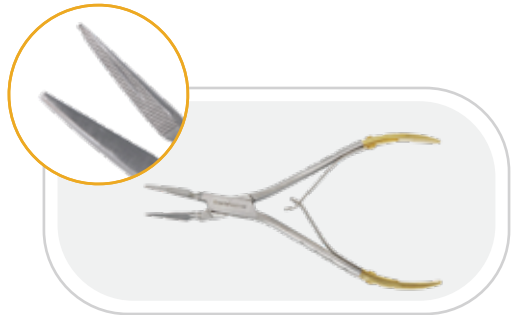

Minnesota Retractor

Veterinary
Use Only

Code	L
800012	155mm



Dental Instruments

Winged Elevator

Veterinary
Use Only

Code	Head Width	L
800008	1mm	150mm
800009	2mm	150mm
800010	3mm	150mm
800011	4mm	150mm

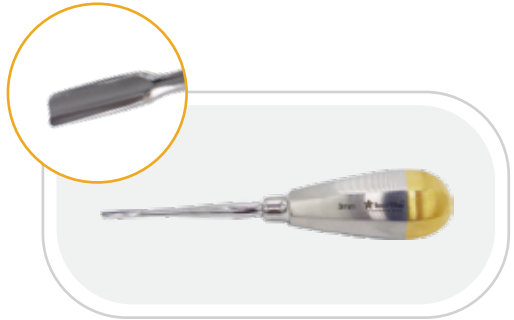

Straight Root Tip Pick

Veterinary
Use Only

Code	L
800013	150mm

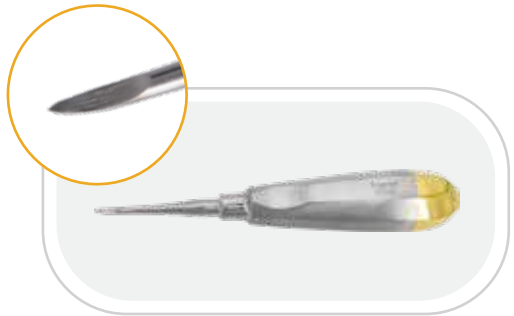

Periosteal Elevator

Veterinary
Use Only

Code	L
800014	150mm



Small Animal Dental Instruments Set



Small Animal Dental Instruments Set

Code	Products Name/Specification	Quantity
000015A	Small Animal Dental Instruments Set	
800001	Sickle Scaler	1
800002	Very Fine Periosteal Elevator	1
800003	Explorer/Measuring Probe	1
800004	Jaquette Supragingival Scaler	1
800005	Subgingival Curette	1
800006	Tartar Removing Forceps	1
800007	Extraction Forceps	1
800008	Winged Elevator 1mm	1
800009	Winged Elevator 2mm	1
800010	Winged Elevator 3mm	1
800011	Winged Elevator 4mm	1
800012	Minnesota Retractor	1
800013	Straight Root Tip Pick	1
800014	Periosteal Elevator	1
800015	Fragment Extraction Forceps	1
000015E	Sterilization Case 265X185X75mm	1

Rodent Dental Instruments

Up Incisor Teeth Dental Elevator

Veterinary
Use Only

Code	L
800016	185mm

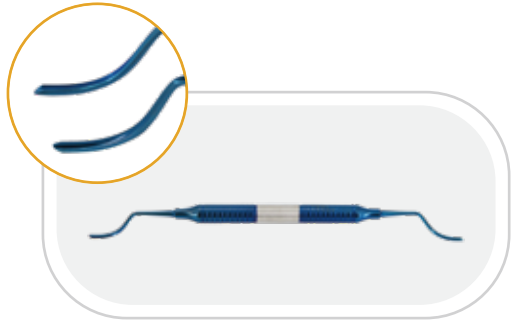

Descend Incisor Teeth Dental Elevator

Veterinary
Use Only

Code	L
800017	190mm

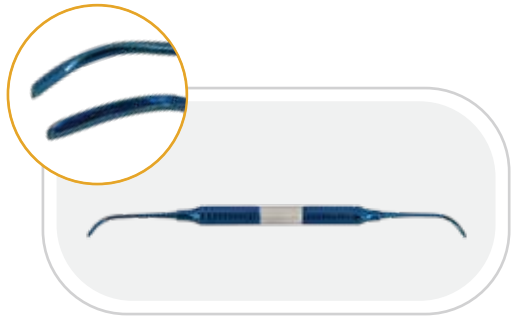

Incisor Teeth Dental Elevator

Veterinary
Use Only

Code	L
800018	180mm

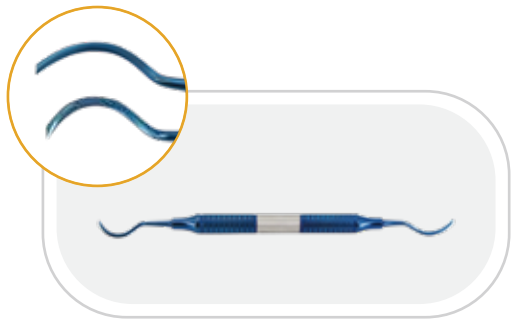

Rodent Dental Instruments

Grind Teeth Dental Elevator

Veterinary
Use Only

Code	L
800019	175mm



Rodent Teeth Rasp

Veterinary
Use Only

Code	L
800020	180mm



Rodent Tongue Depressor

Veterinary
Use Only

Code	L
800021	168mm



Rodent Dental Instruments

Rodent Lip Buccal Pressing Plate

Veterinary
Use Only

Code L

800022 170mm



Grind Teeth Shear

Veterinary
Use Only

Code L

800023 180mm



Rodent Extraction Forceps

Veterinary
Use Only

Code L

800024 150mm

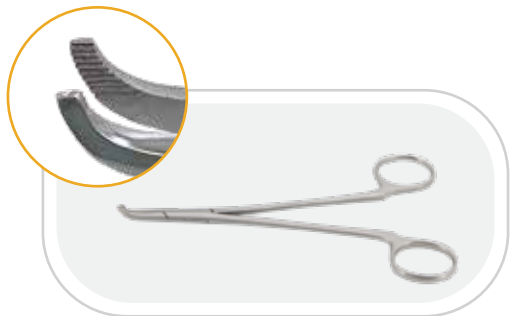

Rodent Dental Instruments

Rodent Mouth Gag(Wire Type)

Veterinary
Use Only

Code	Opening Range
800025	70mm

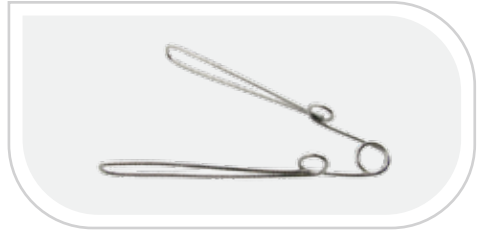

Rodent Mouth Gag

Veterinary
Use Only

Code	Opening Range
500060	0-50mm



Rabbit Mouth Gag

Veterinary
Use Only

Code	Opening Range	L
500069	43mm	117mm



Rodent Dental Instruments

Cheek Side Dilator (Long Reach Curved)

Veterinary
Use Only

Code	Specification	Opening Range	Depth
500071	Small	50mm	30mm
500072	Large	65mm	40mm

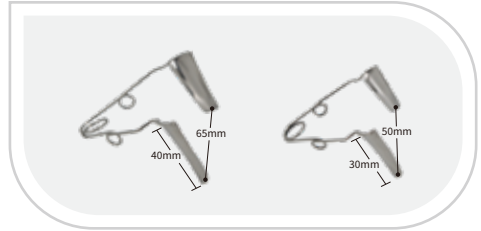

Table Top Mouth Gag (Rabbit/Rodent)

Veterinary
Use Only

Code
800029



Table Top Mouth Gag Adjustable

Veterinary
Use Only

Code
800030



Rodent Dental Instrument Set



Rodent Dental Instrument Set

Code	Products Name/Specification	Quantity
800016	Up Incisor Teeth Dental Elevator	1
800017	Descend Incisor Teeth Dental Elevator	1
800018	Incisor Teeth Dental Elevator	1
800019	Grind Teeth Dental Elevator	1
800020	Rodent Teeth Rasp	1
800021	Rodent Tongue Depressor	1
800022	Rodent Lip Buccal Pressing Plate	1
800023	Grind Teeth Shear	1
800024	Rodent Extraction Forceps	1
500071	Small Cheek Side Dilator (Long Reach Curved)	1
500072	Large Cheek Side Dilator (Long Reach Curved)	1
100079	Micro Friedman Rongeur Curved	1
200005	Sterilization Case	1

Ophthalmology Instruments



Ophthalmology Surgery Instrument

Halstead Mosquito Forceps

Veterinary Use Only

Code	Specification	L
900001	Straight	95mm
900002	Curved	95mm



NO-3 Standard Scalpel Handles

Veterinary Use Only

Code	Specification
500036	NO-3



Stitch Scissors

Veterinary Use Only

Code	L
900004	105mm



Ophthalmology Surgery Instrument

Eye Scissors

Veterinary
Use Only

Code	Specification	L
900005	Straight	95mm
900006	Curved	95mm

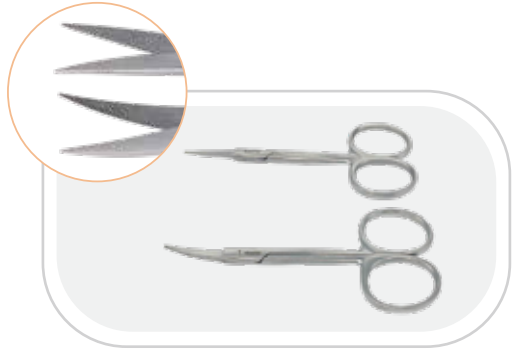

Harms Tying Forceps

Veterinary
Use Only

Code	Specification	L
900007	Straight	100mm
900007b	Curved	100mm



Bishop-Harmon Forceps

Veterinary
Use Only

Code	Specification	L
900008	Tissue Forceps 1X2 Teeth	85mm
900009	Serrated Forceps	85mm



Ophthalmology Surgery Instrument

Capsulorhexis Tweezers

Veterinary Use Only

Code	Specification	L
900028	Curved	100mm



Westcott Tenotomy Scissors

Veterinary Use Only

Code	Specification	L
900010	Medium Blades Curved	110mm



Castroviejo Comeoscleral Scissors

Veterinary Use Only

Code	Specification
900011	Medium Blades Curved Right
900012	Medium Blades Curved Left

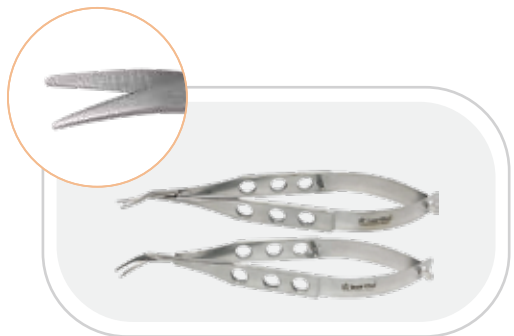

Ophthalmology Surgery Instrument

Castroviejo Needle Holder

Veterinary
Use Only

Code

900013

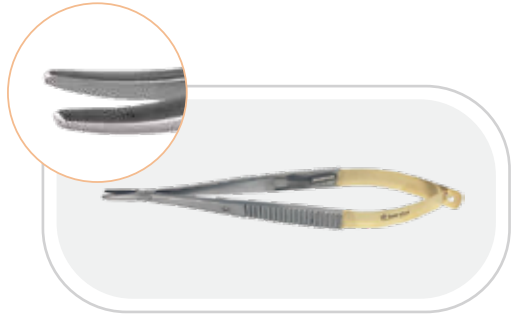

Castroviejo Eye Speculum

Veterinary
Use Only

Code

900014

Specification

Small

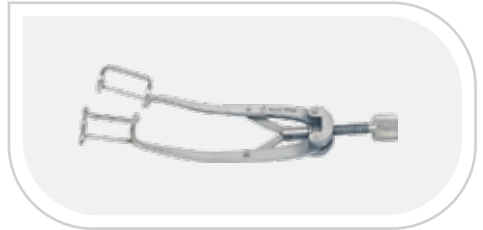

Barraquer Wire Eyelid Speculum

Veterinary
Use Only

Code

900015

Specification

Small

L

10mm

900016

Large

14mm

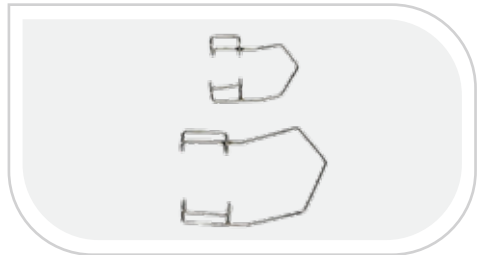

Ophthalmology Surgery Instrument

Desmarres Chalazion Forceps

Veterinary Use Only

Code	Width	L
900017	16mm	90mm



Graefe Fixation Forceps

Veterinary Use Only

Code	L
900018	115mm



Conjunctival scissors

Veterinary Use Only

Code	Specification	L
900019	Curved	8.5mm



Ophthalmology Surgery Instrument

Titanium Bishop-Harmon Forceps

Veterinary
Use Only

Code	Specification	Head Width	L
900020	Serrated	0.8mm	110mm
900021	1/2 Teeth	0.25mm	110mm

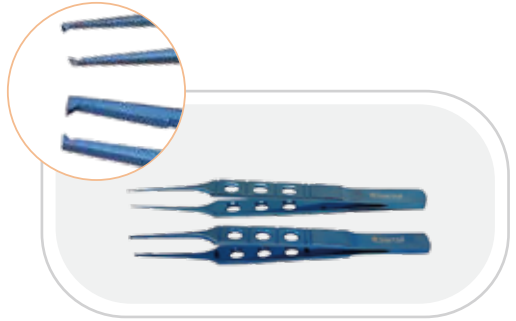

Titanium Needle Holder

Veterinary
Use Only

Code	Specification	L
900022	Curved	125mm

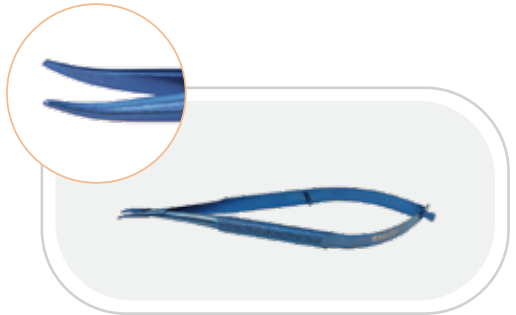

Titanium Eye Scissors

Veterinary
Use Only

Code
900023

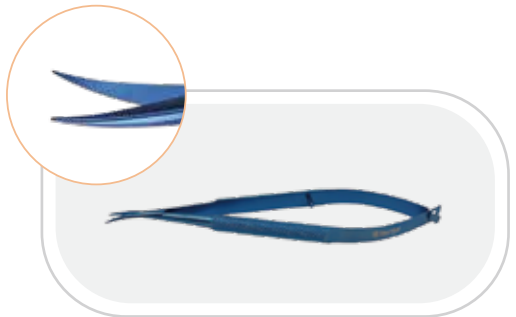

Ophthalmology Surgery Instrument

Titanium Barraquer Wire Eyelid Speculum

Veterinary Use Only

Code	Specification	L
900024	A	45mm
900025	B	45mm

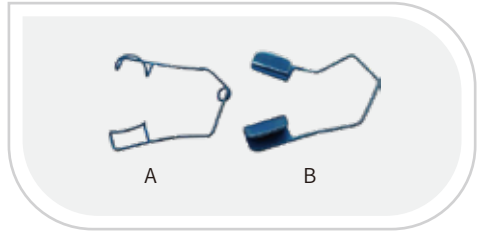

Sterilization Container

Veterinary Use Only

Code	Specification
900026	265mmX160mmX22mm

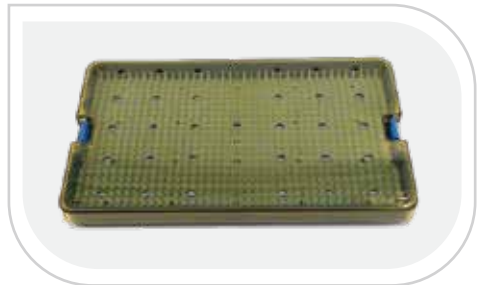

Small Animal Ophthalmology Instruments

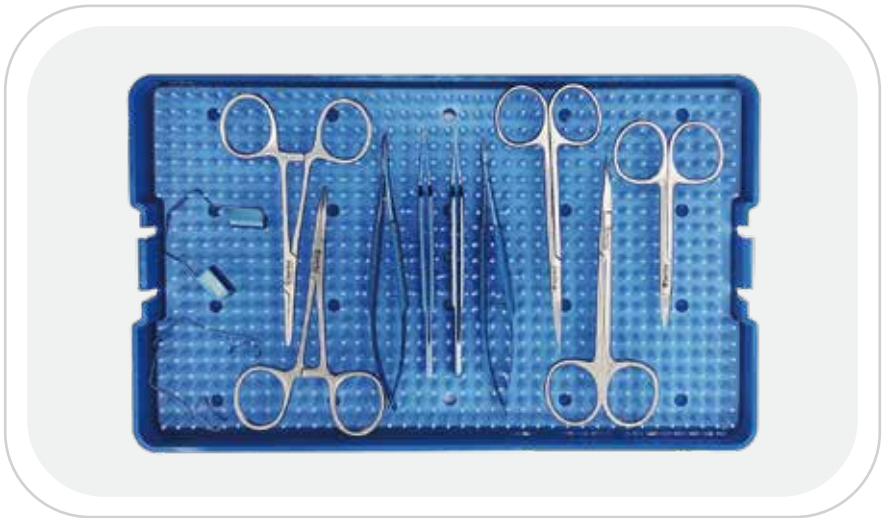

Small Animal Ophthalmology Instruments

Code	Products Name/Specification	Quantity
910001	Small Animal Ophthalmology Instruments	
900020	Tanium Bishop-Harmon Forceps-Serrated Head Width 0.8mm L 110mm	1
900021	Tanium Bishop-Harmon Forceps-1/2 Teeth Head Width 0.25mm L 110mm	1
900005	Eye Scissors Straight 100mm	1
900006	Eye Scissors Curved 100mm	1
900019	Conjunctival Scissors	1
900022	Titanium Needle Holder Curved 125mm	1
900023	Titanium Eye Scissors Curved 125mm	1
900024	Titanium Barraquer Wire Eyelid Speculum-A	1
900025	Titanium Barraquer Wire Eyelid Speculum-B	1
900001	Halstead mosquito Forceps Straight L 125mm	1
900002	Halstead mosquito Forceps Curved L 125mm	1
900026	Sterilization Case	1

Small Animal Ophthalmology Instruments



Small Animal Ophthalmology Instruments

Code	Products Name/Specification	Quantity
910002	Small Animal Ophthalmology Instruments	
900008	Bishop-Harmon Tissue Forceps 1X2 Teeth 85mm	1
900009	Bishop-Harmon Dressing Forceps, rris-cross serrated tips 85mm	1
900007	Harms Tying Forceps Straight 100mm	1
900007b	Harms Tying Forceps Curved 100mm	1
900010	Westcott Tenotomy Scissors Medium Blades Curved	1
900011	Castroviejo Corneoscleral Scissors right Medium Blades Curved Right	1
900012	Castroviejo Corneoscleral Scissors left Medium Blades Curved Left	1
900013	Castroviejo Needle Holder Curved With Lock	1
900005	Eye Scissors Straight 95mm	1
900006	Eye Scissors Curved 95mm	1
900004	Stitch Scissors Curved 105mm	1
900014	Castroviejo Eye Speculum Small	1
900015	Barraquer Wire Eyelid Speculum Small 10mm	1
900016	Barraquer Wire Eyelid Speculum Large 14mm	1
500036	Standard NO-3 Scalpel Handles	1
900001	Halstead Mosquito Forceps Straight 100mm	1
900002	Halstead Mosquito Forceps 100mm Curved	1
900017	Desmarres Chalazion Forceps Width 16mm L 90mm	1
900018	Graefe Fixation Forceps 115mm	1
200003	Sterlization Container	1



BIORTHO Co., LTD

TEL: 15162363967

EMAIL: vet@biortho.cn

www.biortho.cn

Whatsapp: +86 15162363967